

Obstacle Detection Sensor PX-2 Series

MJE-PX2 No.0034-73V

Thank you very much for purchasing Panasonic products. Please read this Instruction Manual carefully and thoroughly for the correct and optimum use of this product. Kindly keep this manual in a convenient place for quick reference.

Hazard Indications

In this Instruction Manual, **WARNING** and **CAUTION** are indicated depending upon the level of danger. Please observe them strictly for the safe use of this sensor.

WARNING

If you ignore the advice with this mark, death or serious injury could result.

CAUTION

If you ignore the advice with this mark, injury or material damage could result.

WARNING

● **Installation of a touch bumper**

You are requested to always install a touch bumper when this product is used on an automatic guided vehicle (AGV).

CAUTION

● **Use outside Japan**

This sensor conforms to the EMC directive. However, it is not certified by a competent body in accordance with other country safety standards. Since each country has its regulations, please follow the local and national regulations of the country where this sensor is used.

CAUTION

● **Fail-safe measures**

This sensor is meant for proximity detection and does not possess control functions for safety maintenance.

If fail-safe measures are required, consider their incorporation in the total system.

Further, do not connect the sensor output directly to a stopping mechanism (brake).

CAUTION

● **Periodical maintenance check**

The person incharge must periodically confirm the performance of the product and maintain a record of such checks. In addition, whenever the operating environment of the product is changed due to system modification, etc., performance check must be done.

1 SPECIFICATIONS

Type	Standard model			Auxiliary sensor connectable model			
	Model No.	PX-22	PX-21	PX-24	PX-24ES	PX-23ES	PX-26
Sensing range (Note 1) (OUT 1 and OUT 2 areas)	3m	1m	3m	3m	1m	5m	5m
Hysteresis	15% or less of operation distance						
Supply voltage	10 to 31V DC including ripple						
Power consumption (Note 2)	Under operation: 1.5W or less, Under sleep condition: 0.3W or less (without auxiliary sensor)						
Outputs	OUT 1 (OR circuit among the effective center, left, right, adjacent left / right OUT 1 areas and the effective auxiliary left / right areas)	NPN open-collector transistor • Maximum sink current: 100mA • Applied voltage: 40V DC or less (between OUT 1 / OUT 2 and 0V) • Residual voltage: 1.5V or less (at 100mA sink current) 0.4V or less (at 16mA sink current)					
	OUT 2 (OR circuit among the effective center, left, and right OUT 2 areas)						
	Output operation	Selectable either Light-ON or Dark-ON with a switch (Output operation of OUT 1 and OUT 2 is the same.)					
	Short-circuit protection	Incorporated					
Extraneous light monitor output	Output operation	NPN open-collector transistor • Maximum sink current: 100mA • Applied voltage: 40V DC or less (between extraneous light monitor output and 0V) • Residual voltage: 1.5V or less (at 100mA sink current) 0.4V or less (at 16mA sink current)					
	Short-circuit protection	—					
	Output operation	ON when modulated beam other than its own (including auxiliary sensor's light is received)					
Response time	80ms or less						
Inputs	Right OUT 1 auxiliary area cancel input Left OUT 1 auxiliary area cancel input	—			Connected to 0 to +1V or GND (0V): Auxiliary area ineffective Connected to 4.5 to 31V, or open: Auxiliary area effective		
	Sleep input	Connected to 0 to +1V or GND (0V): Sleep condition Connected to (supply voltage - 1V) to 31V, or open: Operational condition.					
	External sensitivity adjustment input	—			Sensitivity of all areas (except auxiliary area changes simultaneously in response to the external analog voltage input (0 to +5V)		
OUT 1 area operation indicator	Red LED (lights up when the beam is received in the effective OUT 1 areas)						
OUT 2 area operation indicator	Yellow LED (lights up when the beam is received in the effective OUT 2 areas)						
Sensitivity adjuster	Continuously variable adjusters (OUT 1, adjacent right OUT 1, adjacent left OUT 1 and OUT 2 areas are adjusted independently.)						
Sensing area	Four sensing areas are selectable with dip switches.			Four sensing areas are selectable with dip switches, and eight sensing areas are selectable with external inputs.		Fixed	
Automatic interference prevention function	Optical interference from up to 25 units is prevented.						
Protection	IP65 (IEC)						
Ambient temperature	-10 to +55°C (No dew condensation or icing allowed), Storage: -20 to +70°C						
Ambient humidity	35 to 85% RH, Storage: 35 to 85% RH						
Emitting element	Infrared LED (modulated)						
Material	Enclosure: ABS, Lens: Acrylic, Cover: Polycarbonate						
Cable	0.3mm ² 5-core cabtyre cable, 0.5m long (for input and output)			For input and output: 0.18mm ² 9-core (PX-24ES and PX-23ES: 12-core) cabtyre cable, 0.5m long For auxiliary sensor connection: 0.18mm ² 10-core connector attached cabtyre cable, 0.5m long			
Weight	170g approx.	210g approx.	220g approx.	210g approx.	220g approx.	210g approx.	
Accessories	MS-PX-2 (Main sensor mounting bracket): 1 set, Adjusting screwdriver: 1 pc. Matrix chart for sensing areas and external inputs 1 sheet (PX-24ES and PX-23ES only)						

Notes: 1) The sensing range is specified for white non-glossy paper (300 × 300mm).
2) Obtain the current consumption by the following calculation.
Current consumption = Power consumption ÷ Supply voltage
(e.g.) When the supply voltage is 12V, the current consumption (operating condition) is:
1.5W ÷ 12V = 0.125A = 125mA

2 MOUNTING

- The tightening torque should be 1.2N·m or less.

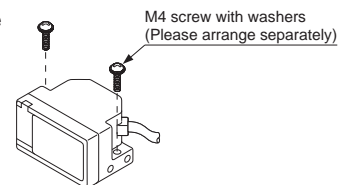

<On main sensor mounting bracket (MS-PX-2)>

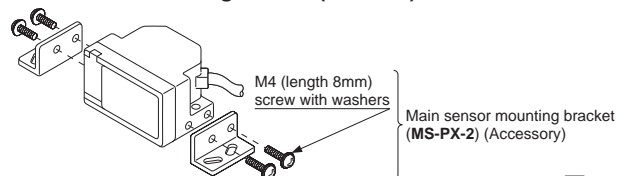

- Mount the sensor, horizontally, at least 300mm above the floor, to avoid reflection from the floor.

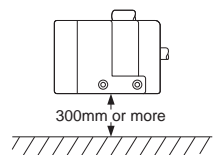

3 CAUTIONS

- This product has been developed / produced for industrial use only.
- Make sure that the power supply is off while wiring.
- Take care that wrong wiring will damage the sensor.
- Verify that the supply voltage variation is within the rating.
- If power is supplied from a commercial switching regulator, ensure that the frame ground (F.G.) terminal of the power supply is connected to an actual ground.
- In case noise generating equipment (switching regulator, inverter motor, etc.) is used in the vicinity of this product, connect the frame ground (F.G.) terminal of the equipment to an actual ground.
- Do not run the wires together with high-voltage lines or power lines or put them in the same raceway. This can cause malfunction due to induction.
- Do not use during the initial transient time (0.7 sec.) after the power supply is switched on.
- Take care that the sensor is not directly exposed to fluorescent lamp from a rapid-starter lamp, a high frequency lighting device or sunlight etc., as it may affect the sensing performance.
- Extension up to total 100m, or less, is possible with 0.3mm², or more, cable. However, take care against any noise added to the input wire of **PX-24, PX-24ES, PX-23ES or PX-26**.

Since the voltage drops due to cable extension, make sure that the supply voltage is within 10 to 31V DC at the sensor.

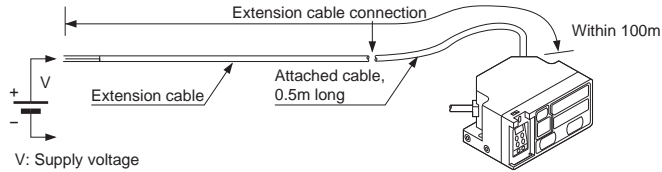

V: Supply voltage

- Note that a rush current (1.5A approx. at 10V, 5A approx. at 31V) flows when the power is supplied.
- When using several sensors, one sensor should not simultaneously receive light from more than 25 other sensors.
- The sensor must be used where no specular objects, such as, a mirror, exist in the background beyond the object.
- The sensing range varies with color, gloss or size of the object. Check the sensing range using the actual object before operation.

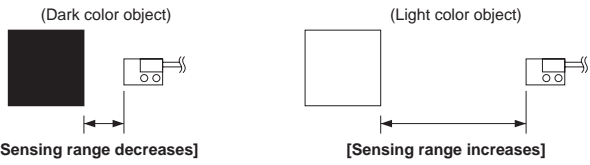

- Make sure that stress by forcible bend or pulling is not applied to the sensor cable joint.
- This sensor is suitable for indoor use only.
- Do not use this sensor in places having excessive vapor, dust, etc., or where it may come in contact with corrosive gas.
- Take care that the sensor does not come in direct contact with oil, grease, organic solvents, such as, thinner etc., or strong acid, and alkaline.

4 I/O CIRCUIT DIAGRAMS

● PX-22, PX-21

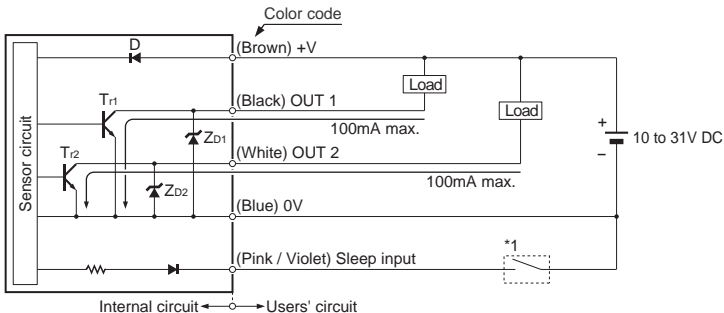

Symbols...D: Reverse supply polarity protection diode
Zd1, Zd2: Surge absorption zener diode
Tr1, Tr2: NPN output transistor

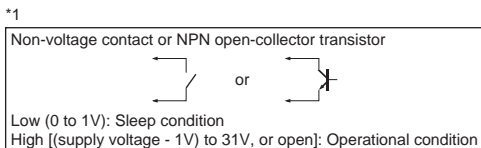

● PX-24, PX-26

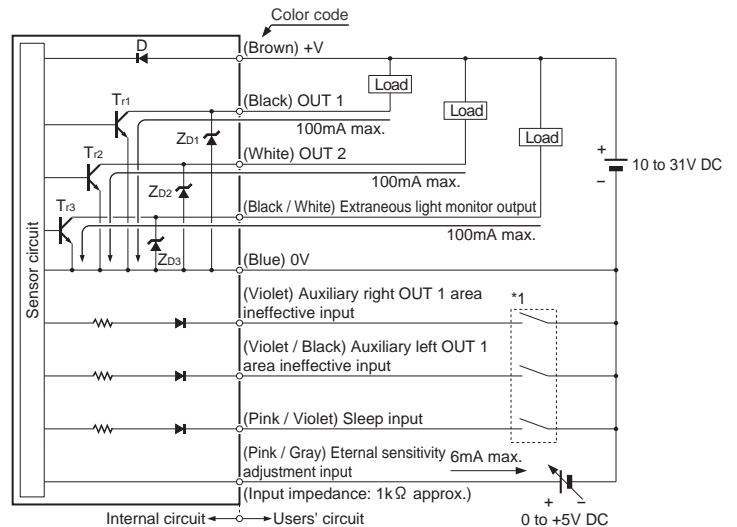

Symbols...D: Reverse supply polarity protection diode
Zd1, Zd2, Zd3: Surge absorption zener diode
Tr1, Tr2, Tr3: NPN output transistor

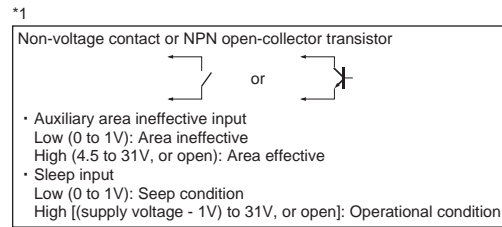

● PX-24ES, PX-23ES

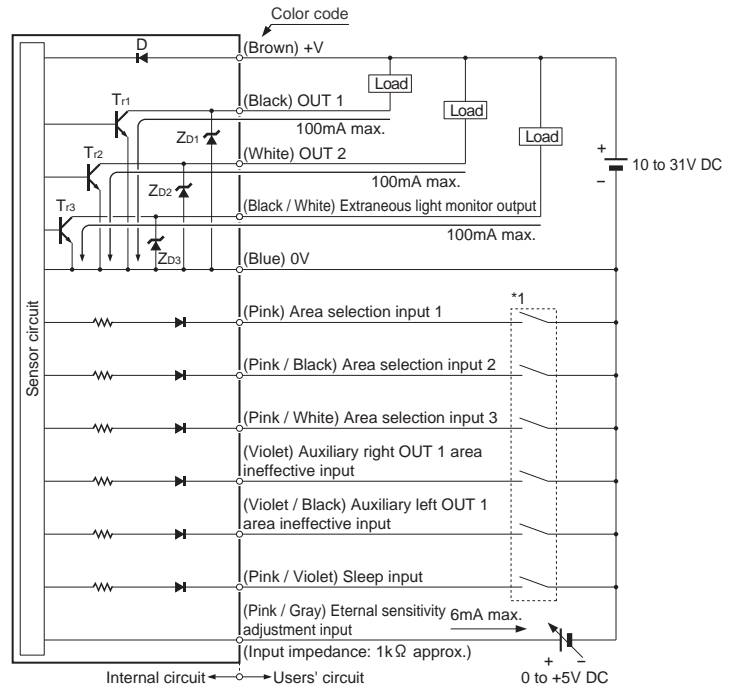

Symbols...D: Reverse supply polarity protection diode
Zd1, Zd2, Zd3: Surge absorption zener diode
Tr1, Tr2, Tr3: NPN output transistor

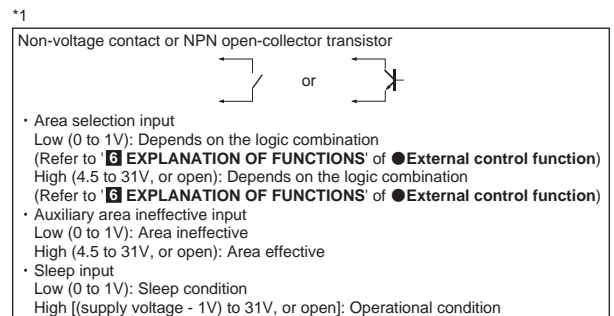

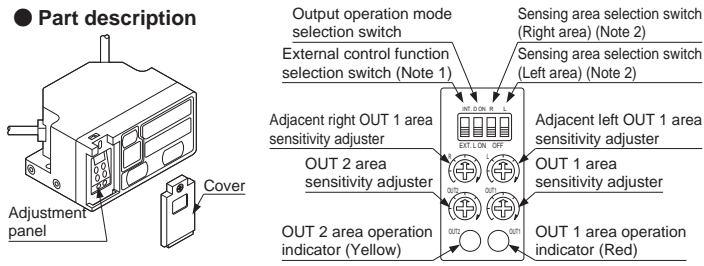

5 SETTING

● Part description





Notes: 1) Incorporated in **PX-24ES** and **PX-23ES**.
2) Not incorporated in **PX-26**.

● Setting procedure

Step	Item	Description	Remarks	
①	Mounting and preparation	Mount the main sensor at the required location. Open the adjustment panel cover.	Refer to 2 MOUNTING .	
②	Connection of auxiliary sensor (Note 1)	If you expect to use the optional auxiliary sensors (PX-SB1), connect them to the main sensor and install them. (Note 2)	Refer to the instruction manual enclosed with auxiliary sensor (PX-SB1).	
③	Selection of main sensor sensing areas	Select the sensing area of the main sensor with the sensing area selection switch. Refer to ● Selection of sensing area . For PX-24ES and PX-23ES , set the external control function selection switch in the adjustment panel to 'INT.' side.	<ul style="list-style-type: none"> Sensing area of PX-26 main sensor is not selectable. PX-24ES and PX-23ES allow sensing area selection with external signal, too. (Refer to 6 EXPLANATION OF FUNCTIONS of ● External control function.) 	
④	Sensitivity adjustment	OUT 2 area	Adjust the OUT 2 area sensitivity with the OUT 2 area sensitivity adjuster.	OUT 2 area = { Left area + Center area + Right area } (Refer to ● OUT 2 area and OUT 1 area .)
		OUT 1 area	Adjust the OUT 1 area sensitivity with the OUT 1 area sensitivity adjuster.	OUT 1 area = { Left area + Center area + Right area } (Refer to ● OUT 2 area and OUT 1 area .)
		Adjacent right OUT 1 area Adjacent left OUT 1 area	Adjust the sensitivity for the adjacent right OUT 1 area and adjacent left OUT 1 area with their sensitivity adjusters.	Sensitivity for OUT 2 area, OUT 1 area, adjacent right OUT 1 area and adjacent left OUT 1 area can be adjusted independently.
		Right OUT 1 auxiliary area Left OUT 1 auxiliary area (Note 1)	Adjust the sensitivity for the right OUT 1 auxiliary area and left OUT 1 auxiliary area with the sensitivity adjusters of the auxiliary sensor (PX-SB1).	Refer to the instruction manual enclosed with auxiliary sensor (PX-SB1).
⑤	Operation mode selection	Select the operation mode for OUT 1 and OUT 2 with the operation mode selection switch.  Light-ON  Dark-ON	OUT 1 and OUT 2 operate in the same mode. (Select either of the two.) <ul style="list-style-type: none"> Both Light-ON. Both Dark-ON. 	
⑥	—	After completion of the above adjustments, the adjustment panel cover must be fitted back on the adjustment panel.	The tightening torque should be 0.5N·m or less.	

Notes: 1) Not required when auxiliary sensor (**PX-SB1**) is not used.
2) Max. two auxiliary sensors can be connected.

● Sensitivity adjustment procedure





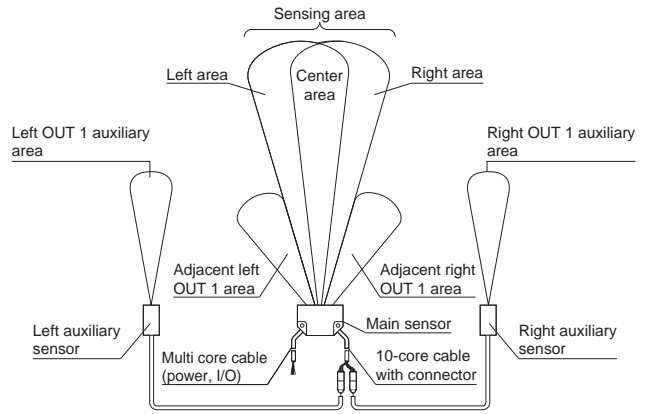

Step	Sensitivity adjustment	Operation
①	—	Set the output operation mode switch to the L. ON mode position (Light-ON).
②		Turn the sensitivity adjuster fully counterclockwise to the minimum sensing range position.
③		Place an object to be detected at the required sensing position, and turn the sensitivity adjuster gradually clockwise and mark the point A where the indicator turns on (Note 1).
④		Remove the object and turn the sensitivity adjuster further clockwise. Find out the point B where the indicator turns on again. Make sure that the difference between point A and B is 1 div., or more, on the scale. Then, set the sensitivity adjuster at point A .
⑤	—	Carry out steps ②, ③ and ④ for each of the areas OUT 2, OUT 1, adjacent left / right OUT 1 and auxiliary sensors (if they are connected).
⑥	—	After all the adjustments are made, the operator must confirm that the sensing area is set correctly by observing the detection of the object as it approaches from different directions.

Notes: 1) When adjusting the sensitivity of OUT 1 area, adjacent right OUT 1 area and adjacent left OUT 1 area, this is the OUT 1 area operation indicator (red).
When adjusting the sensitivity of OUT 2 area, this is the OUT 2 area operation indicator (yellow).
2) Set areas other than the area you are adjusting as ineffective.
3) Use the accessory adjuster screwdriver to turn the distance adjuster slowly. Turning with excessive force will cause damage to the adjuster.
4) During the sensitivity adjustment, do not let your hand be detected.
5) Sensitivity adjustment for the auxiliary sensor is performed with the sensitivity adjuster on the auxiliary sensor (**PX-SB1**). Refer to the instruction manual enclosed with auxiliary sensor (**PX-SB1**).
6) After sensitivity adjustment, fit the adjustment panel cover using the accessory adjuster screwdriver. The tightening torque should be 0.5N·m or less.

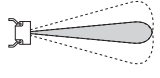
● Description of sensing areas

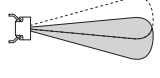

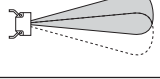
● Selection of sensing area

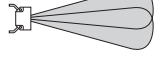
Sensing area selection switch	Sensing area pattern of main sensor	
	Right and left sides are ineffective. (Sensing width is minimum.)	
	Right side is effective. Left side is ineffective. (Sensing width is narrow on the left side.)	
	Right side is ineffective. Left side is effective. (Sensing width is narrow on the right side.)	
	Right and left sides are effective. (Sensing width is maximum.)	

Note: Adjacent left and right OUT 1 areas are always effective.
To make them ineffective, turn their sensitivity adjusters fully counterclockwise.

● OUT 2 area and OUT 1 area

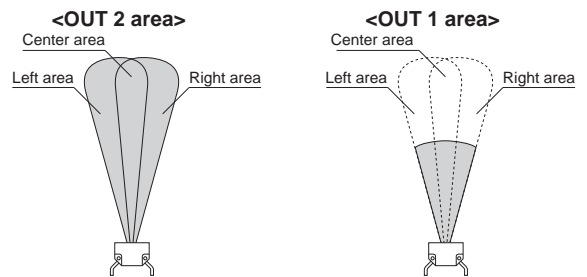

Note: The sensitivity of the OUT 2 and the OUT 1 areas can be adjusted independently. Thus the OUT 1 area can be set for a longer range than the OUT 2 area, in which case OUT 1 turns ON before OUT 2.

● Relationship between OUT 2, OUT 1 and effective area

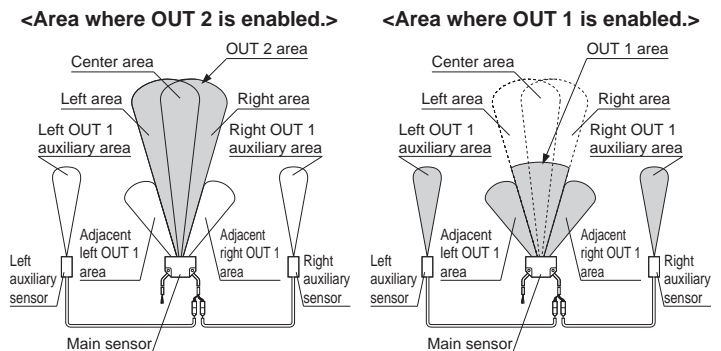

6 EXPLANATION OF FUNCTIONS

● Automatic interference prevention function

- In case several sensors are used at the same place, take care that the number of sensors from which beams may be simultaneously incident is 25 sensors or less.

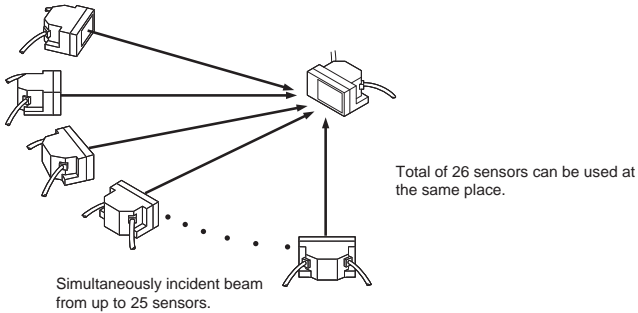

● Sleep function (Incorporated in all models)

- When the sleep input is made Low, the sensor goes into the sleep state and the operation can be stopped. Power consumption during the sleep state is 0.3W max. (Without auxiliary sensors).

Notes: 1) Response time of the sleep input is 50ms.
 2) Reactivation from the sleep state to the operation state takes 0.7 sec. approx. Operation during this transient state should be avoided.
 3) When the sleep function is not used, keep the sleep input wire open or insulated and prevent contact with other wires.

● External sensitivity adjustment function (Incorporated in PX-24, PX-24ES, PX-23ES and PX-26 only)

- The sensitivity can be adjusted, within the range set by the manual sensitivity adjuster, by an analog voltage (0 to +5V) applied to the external sensitivity adjustment input. The sensitivity varies with the magnitude of the applied voltage.

Notes: 1) The sensitivity of the auxiliary sensor is not changed by this function.
 2) The sensitivity cannot be adjusted beyond the range set by the manual adjuster.
 3) When the external sensitivity adjustment function is not used, keep the external sensitivity adjustment input wire open or insulated and prevent contact with other wires.

Input voltage	0V ← → +5V, or open
Sensitivity	Minimum ← → Maximum (Max. sensitivity set by the manual adjuster)

● Auxiliary area switching function (Incorporated in PX-24, PX-24ES, PX-23ES and PX-26 only)

- When the auxiliary sensors (PX-SB1) are connected to the main sensor, the auxiliary area can be made effective or ineffective with an external input. For details refer to the instruction manual enclosed with auxiliary sensor (PX-SB1).

Note: When the auxiliary area switching function is not used, keep the auxiliary area switching input wire open or insulated and prevent contact with other wires.

● Extraneous light monitor function (Incorporated in PX-24, PX-24ES, PX-23ES and PX-26 only)

- If the sensor receives modulated light other than its own (including auxiliary sensor's) light, the extraneous light monitor output turns ON. The operation of the extraneous light monitor output has absolutely no affect on sensing. It is useful in recognizing presence of other sensors near this sensor in case of intersecting AGV paths, etc.

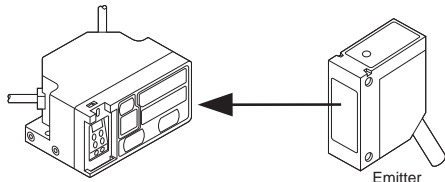

Note: The extraneous light monitor output is not incorporated with a short-circuit protection circuit. Do not connect it directly to a power supply or a capacitive load.

● External control function

■ (Incorporated in PX-24ES and PX-23ES only)

PX-24ES and PX-23ES incorporate an external control function. Set the external control function selection switch on the adjustment panel to 'EXT.' side. Then, the sensing area of the main sensor can be selected by external signals.

Sensing area	Setting method	Area selection input		
		Input 1	Input 2	Input 3
All areas ineffective		L	L	L
Center area effective		H	L	L
Center, right and adjacent right OUT 1 areas effective		L	H	L
Center left and adjacent left OUT 1 areas effective		H	H	L
Center and left / right adjacent OUT 1 areas effective		L	L	H
Center, right and adjacent left / right OUT 1 areas effective		H	L	H
Center, left and adjacent left / right OUT 1 areas effective		L	H	H
All areas effective		H	H	H

L: Low (0 to 1V), H: High (4.5 to 31V, or open)

Notes: 1) Response time of area the selection input is 80ms.
 2) Set the external control selection switch to 'EXT.' side.

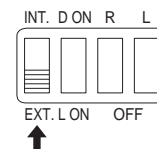

7 INTENDED PRODUCTS FOR CE MARKING

- The models listed under "1 SPECIFICATIONS" come with CE Marking. As for all other models, please contact our office.



● Contact for CE

<Until June 30 ,2013>
 Panasonic Electric Works Europe AG
 Rudolf-Diesel-Ring 2, D-83607 Holzkirchen, Germany
 <From July 1 ,2013>
 Panasonic Marketing Europe GmbH Panasonic Testing Center
 Winsbergring 15, 22525 Hamburg,Germany

Panasonic Industrial Devices SUNX Co., Ltd.

<http://panasonic.net/id/pidsx/global>

Overseas Sales Division (Head Office)

2431-1 Ushiyama-cho, Kasugai-shi, Aichi, 486-0901, Japan
 Phone: +81-568-33-7861 FAX: +81-568-33-8591

About our sale network, please visit our website.

PRINTED IN JAPAN

© Panasonic Industrial Devices SUNX Co., Ltd. 2012