

LS-551-0200-LIU22PN8X-H1151

Level Sensor for Liquids – With Analog Output and 2 × Switching Outputs

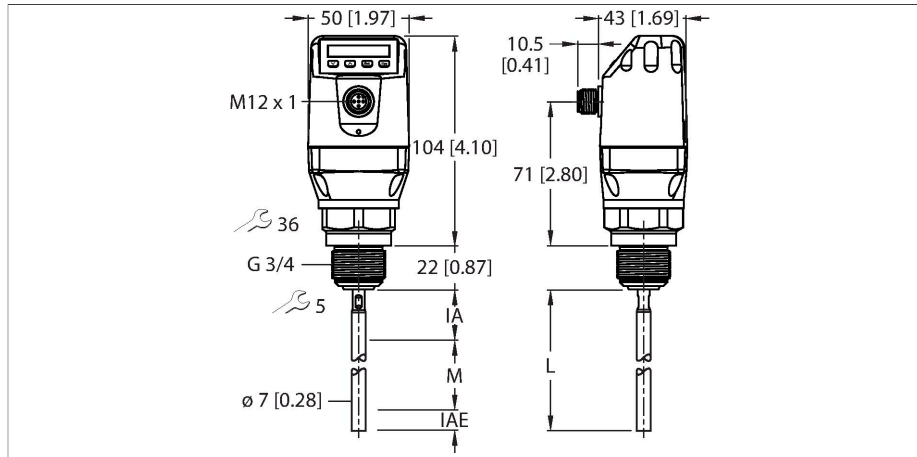

Features

- Multiple output signals: one system for both level detection and continuous level monitoring
- Low maintenance and quick commissioning without calibration
- High flexibility due to cuttable probe
- Compact, rotatable display housing ensures easy installation
- Small inactive areas, ideal for small containers
- Process temperature to 212 °F
- Process pressure up to 145 psi
- Coaxial tubes available for non-metallic tanks
- IO-Link 1.1
- 12...30 VDC
- 1 × analog output 4... 20 mA/0... 10 V (automatic switchover depending on load)
- 1 × transistor output (PNP) or IO-Link
- 1 × transistor output (PNP/NPN switchable)
- Process connection G3/4" male thread
- Probe length 200 mm

Technical data

Type	LS-551-0200-LIU22PN8X-H1151
Ident. no.	100001848
Medium temperature	-20...+100 °C
Application area	liquids
Probe length (L)	200 mm
Max. loading of probe	6 Nm
Probe accuracy	± 5 mm
Temperature drift	≤ 0.1
Hysteresis	≥ 2 mm
Repeatability	≤ 2 mm
Inactive area at process connection	25 mm
Inactive area at probe end	10 mm
Dielectric constant	≥ 5; ≥ 1.8 mit Koaxialrohr (Zubehör)
Pressure resistance	-1...10 bar
Electrical data	
Operating voltage	12...30 VDC
Current consumption	≤ 100 mA
Short-circuit/reverse polarity protection	yes / yes
Inductive load	< 1 H
Capacitive load	100 nF
Insulation class	III

Wiring diagram

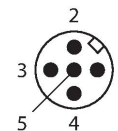
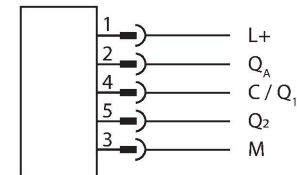

Functional principle

The LS-5 series liquid level sensors uses time-of flight technology to measure electromagnetic waves to generate a level signal. The advanced technology enables calibration free commissioning with probes that can be cut to length for quick integration into most applications. Highly resistant to deposit formations with no moving parts, the LS-5 series offers significant cost saving due to multiple output signals for both continuous level detection and point level monitoring. Simply

setup with four buttons and integral display, or through an IO-Link interface

Technical data

Outputs	
Output 1	Analog output (current/voltage, automatic switching depending on load)
Output 2	IO-Link/switching output (PNP)
Output 3	Switching output (PNP/NPN)
Switching output	
Communication protocol	IO-Link
Output function	NO/NC, PNP/NPN, analog output
Analog output	
Current output	4...20 mA
High level signal current	20...20.5 mA
Low level signal current	3.8...4 mA
Load resistance, current output	≤ 0.5 kΩ
Voltage output	0...10 V
High level signal voltage	U _v - 2 V
Low level signal voltage	≤ 2 V
Load resistance voltage output	≥ 0.75 kΩ
Response time typical	< 400 ms
IO-Link	
IO-Link Specification	V 1.1
IO-Link port type	Class A
Transmission physics	COM 2 (38.4 kBaud)
Frame type	2.2
Included in the SIDI GSDML	Yes
Mechanical data	
Housing material	Plastic, PBT
Materials (contact with media)	Stainless steel, 1.4404, PTFE, FKM
Process connection	G 3/4" male thread
Electrical connection	Connector, M12 × 1
Protection class	IP67
Environmental conditions	
Ambient temperature	-20...+60 °C
Storage temperature	-40...+80 °C
Display functions	
Display	Digital display
MTTF	194 years

Accessories

LSCT-51-0200**100001872**

Coaxial tube for LS-5 level sensors (only G3/4") for use in non-metallic containers, probe length 200 mm, process connection G3/4"

LSCT-34-0200**100001873**

Coaxial tube for LS-5 level sensors (only G3/4") for use in non-metallic containers, probe length 200 mm, process connection 3/4" NPT

LSRP-1000**100002197**

Probe for screwing into LS-5 level sensors, length 1000 mm

Accessories

Accessories