

Manually Set Fiber Sensor FX-311 SERIES

Related Information

- General terms and conditions..... F-7
- Sensor selection guide..... P.3~
- Fiber selection P.5~
- Glossary of terms / General precautions...P.1455~ / P.1458~



* Passed the UL 991 Environment Test

* UL 61010C-1 compatible, Passed the UL 991 Environment Test based on SEMI S2-0200. [Category applicable for semiconductor manufacturing: TWW2, Process Equipment] [Applicable standards: UL 61010C-1] [Additional test / evaluation standards as per intended use: UL 991, SEMI S2-0200]



Highly sensitive manual tuning made easy

12-turn potentiometer with visible indicator

12-turn potentiometer has been incorporated for fine adjustments. It enables detection of very fine differences. Moreover, since the pointer of indicator has a red backlight, you can confirm the position at a glance, even in a dark area.

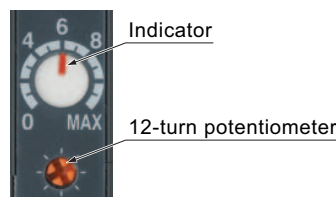

Long life and reduced maintenance work-hours

The light-emitting elements of conventional fiber sensors are affected by temperature and long-term use, changing their emission over time and requiring sensitivity readjustment. **FX-311** (red LED type) employs the new "four-chemical LED", first used in the **FX-301** (red LED type). This emitter greatly reduces adverse influences on emission performance, resulting in stable operation that almost never needs adjustment.

Rapid flashing "assist function" eases adjustment for optimum sensitivity

The **FX-311** series has a convenient built-in "assist function" which indicates the optimum sensitivity position by flashing rapidly when optimum sensitivity is reached. This enables easy and reliable sensitivity adjustment, which is convenient for a narrow sensing range requiring fine tuning.

* In order enable the "assist function", switch the operation selection switch from [L-ON→D-ON→L-ON].

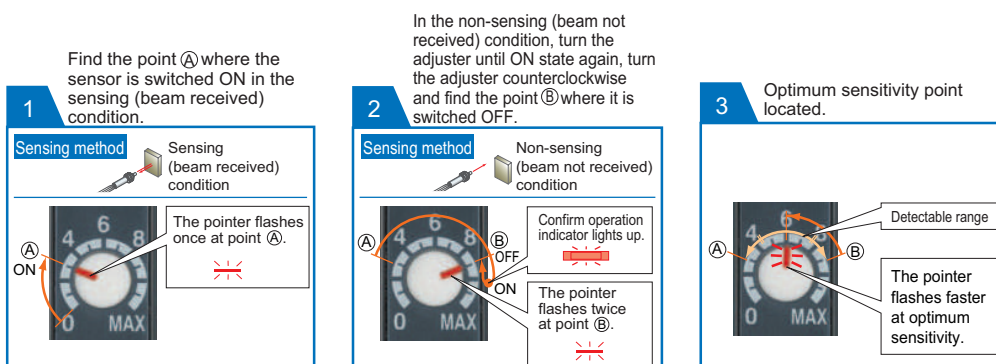

Selection Guide
Fibers
Fiber Amplifiers

- FX-500
- FX-100
- FX-300
- FX-410
- FX-311
- FX-301-F7/ FX-301-F

APPLICATIONS

Detecting register marks

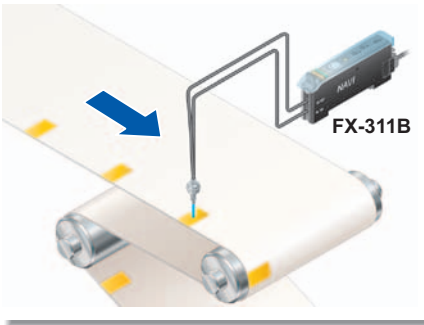

Detecting transparent bottles

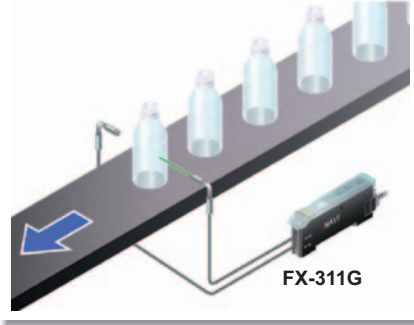

Sensing the presence of a translucent sheet

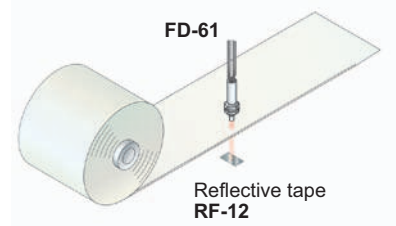

FIBER SENSORS

LASER SENSORS

PHOTO-ELECTRIC SENSORS

MICRO PHOTO-ELECTRIC SENSORS

AREA SENSORS

LIGHT CURTAINS / SAFETY COMPONENTS

PRESSURE / FLOW SENSORS

INDUCTIVE PROXIMITY SENSORS

PARTICULAR USE SENSORS

SENSOR OPTIONS

SIMPLE WIRE-SAVING UNITS

WIRE-SAVING SYSTEMS

MEASUREMENT SENSORS

STATIC ELECTRICITY PREVENTION DEVICES

LASER MARKERS

PLC

HUMAN MACHINE INTERFACES

ENERGY CONSUMPTION VISUALIZATION COMPONENTS

FA COMPONENTS

MACHINE VISION SYSTEMS

UV CURING SYSTEMS

ORDER GUIDE

Amplifiers Quick-connection cable is not supplied with the amplifier. Please order it separately.

Type	Appearance	Model No.	Emitting element	Output
Manually set		FX-311	Red LED	NPN open-collector transistor
		FX-311B	Blue LED	
		FX-311G	Green LED	
		FX-311P	Red LED	PNP open-collector transistor
		FX-311BP	Blue LED	
		FX-311GP	Green LED	

Quick-connection cables Quick-connection cable is not supplied with the amplifier. Please order it separately.

Type	Model No.	Description
Main cable (3-core)	CN-73-C1	Length: 1 m 3.281 ft
	CN-73-C2	Length: 2 m 6.562 ft
	CN-73-C5	Length: 5 m 16.404 ft
Sub cable (1-core)	CN-71-C1	Length: 1 m 3.281 ft
	CN-71-C2	Length: 2 m 6.562 ft
	CN-71-C5	Length: 5 m 16.404 ft

Main cable

- CN-73-C□

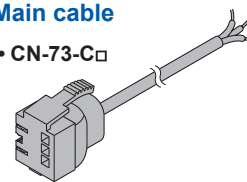

Sub cable

- CN-71-C□

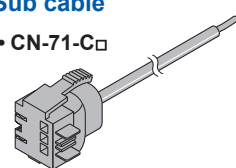

Selection Guide

Fibers

Fiber Amplifiers

FX-500

FX-100

FX-300

FX-410

FX-311

FX-301-F7/
FX-301-F

ORDER GUIDE

End plates End plates are not supplied with the amplifier. Please order them separately when the amplifiers are mounted in cascade.

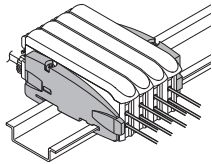
Appearance	Model No.	Description
	MS-DIN-E	When cascading multiple amplifiers, or when it moves depending on the way it is installed on a DIN rail, these end plates clamp amplifiers into place on both sides. Make sure to use end plates when cascading multiple amplifiers together. Two pcs. per set

OPTIONS

Designation	Model No.	Description
Amplifier mounting bracket	MS-DIN-2	Mounting bracket for amplifier
Hand-turned knob attached cover	FX-AJ1	Hand-turned knob allows easy adjustment of sensor sensitivity.
Fiber amplifier protection seal	FX-MB1	10 sets of 2 communication window seals and 1 connector seal Communication window seal: It prevents malfunction due to transmission signal from another amplifier, as well as, prevents effect on another amplifier. Connector seal: It prevents contact of any metal, etc., with the pins of the quick-connection cable.

Amplifier mounting bracket

- **MS-DIN-2**

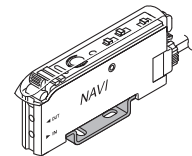

Hand-turned knob attached cover

- **FX-AJ1**

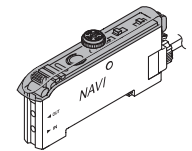

Fiber amplifier protection seal

- **FX-MB1**

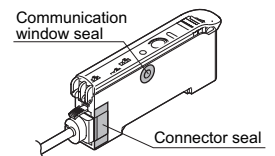

LIST OF FIBERS

Thru-beam type (one pair set)



Fibers are listed in alphabetic order. Refer to p.5~ "Fiber Selection" for details of each fiber.

Model No.	Sensing range (mm in) (Note 1)									Dimensions
	Red LED			Blue LED			Green LED			
	LONG	STD	S-D	LONG	STD	FAST	LONG	STD	FAST	
FT-140	19,600 771.654 (Note 2)	16,000 629.921	8,700 342.520	8,100 318.898	4,000 157.480	3,100 122.047	5,000 196.850	2,400 94.488	1,600 62.992	P.51
FT-30	310 12.205	150 5.906	60 2.362	55 2.165	28 1.102	18 0.709	28 1.102	13 0.512	9 0.354	P.51
FT-31	290 11.417	142 5.591	49 1.929	50 1.969	25 0.984	16 0.630	24 0.945	12 0.472	8 0.315	P.51
FT-31S	290 11.417	140 5.512	49 1.929	50 1.969	25 0.984	16 0.630	24 0.945	12 0.472	8 0.315	P.51
FT-31W	230 9.055	100 3.937	30 1.181	31 1.220	15 0.591	10 0.394	15 0.591	8 0.315	5 0.197	P.51
FT-40	900 35.433	450 17.717	180 7.087	155 6.102	76 2.992	45 1.772	90 3.543	40 1.575	26 1.024	P.51
FT-42	800 31.496	400 15.748	150 5.906	150 5.906	75 2.953	40 1.575	80 3.150	35 1.378	24 0.945	P.51
FT-42S	800 31.496	400 15.748	150 5.906	150 5.906	75 2.953	40 1.575	70 2.756	35 1.378	24 0.945	P.51
FT-42W	710 27.953	330 12.992	130 5.118	110 4.331	50 1.969	30 1.181	56 2.205	28 1.102	20 0.787	P.51
FT-43	1,400 55.118	610 24.016	250 9.843	220 8.661	110 4.331	75 2.953	120 4.724	61 2.402	43 1.693	P.51
FT-45X	1,100 43.307	570 22.441	230 9.055	130 5.118	65 2.559	45 1.772	70 2.756	34 1.339	25 0.984	P.52
FT-A11	3,600 141.732 (Note 2)	2,700 106.299	1,000 39.370	880 34.646	420 16.535	270 10.630	430 16.929	220 8.661	120 4.724	P.52
FT-A11W	3,600 141.732 (Note 2)	3,100 122.047	1,200 47.244	820 32.283	420 16.535	280 11.024	460 18.110	220 8.661	140 5.512	P.52
FT-A32	3,600 141.732 (Note 2)	3,600 141.732	2,900 114.173	1,800 70.866	710 27.953	400 15.748	970 38.189	320 12.598	180 7.087	P.52
FT-A32W	3,600 141.732 (Note 2)	3,600 141.732 (Note 2)	2,100 82.677	2,000 78.740	830 32.677	420 16.535	1,000 39.370	350 13.780	180 7.087	P.52
FT-AL05	680 26.772	330 12.992	130 5.118	100 3.937	48 1.890	32 1.260	56 2.205	27 1.063	18 0.709	P.52
FT-E13	13 0.512	6 0.236	2 0.079	2 0.079	1 0.039	—	1 0.039	—	—	P.52
FT-E23	65 2.559	31 1.220	12 0.472	8 0.315	4 0.157	3 0.118	4 0.157	2 0.079	1 0.039	P.52
FT-H13-FM2	880 34.646	440 17.323	155 6.102	72 2.835	36 1.417	26 1.024	32 1.260	16 0.630	10 0.394	P.52
FT-H20-J20-S (Note 3)	390 15.354	200 7.874	60 2.362	60 2.362	20 0.787	—	35 1.378	—	—	P.53
FT-H20-J30-S (Note 3)	390 15.354	200 7.874	60 2.362	60 2.362	20 0.787	—	35 1.378	—	—	P.53
FT-H20-J50-S (Note 3)	390 15.354	200 7.874	60 2.362	60 2.362	20 0.787	—	35 1.378	—	—	P.53
FT-H20-M1	550 21.654	280 11.024	90 3.543	100 3.937	50 1.969	35 1.378	50 1.969	25 0.984	18 0.709	P.53
FT-H20-VJ50-S (Note 3)	550 21.654	280 11.024	90 3.543	85 3.346	30 1.181	—	50 1.969	—	—	P.53
FT-H20-VJ80-S (Note 3)	550 21.654	280 11.024	90 3.543	85 3.346	30 1.181	—	50 1.969	—	—	P.53
FT-H20W-M1	310 12.205	140 5.512	50 1.969	44 1.732	22 0.866	14 0.551	22 0.866	11 0.433	7 0.276	P.53
FT-H30-M1V-S (Note 4)	250 9.843	125 4.922	50 1.969	—	—	—	—	—	—	P.53
FT-H35-M2	550 21.654	280 11.024	90 3.543	100 3.937	50 1.969	35 1.378	50 1.969	25 0.984	18 0.709	P.53
FT-H35-M2S6	550 21.654	280 11.024	90 3.543	100 3.937	50 1.969	35 1.378	50 1.969	25 0.984	18 0.709	P.53
FT-HL80Y	3,500 137.795	1,350 53.150	480 18.898	80 3.150	40 1.575	25 0.984	110 4.331	55 2.165	40 1.575	P.53
FT-KS40	3,600 141.732 (Note 2)	2,700 106.299	850 33.465	740 29.134	280 11.024	220 8.661	420 16.535	180 7.087	81 3.189	P.54
FT-KV26	710 27.953	310 12.205	120 4.724	81 3.189	36 1.417	21 0.827	44 1.732	8 0.315	—	P.54
FT-KV40	3,600 141.732 (Note 2)	2,500 98.425	1,000 39.370	710 27.953	270 10.630	210 8.268	420 16.535	180 7.087	100 3.937	P.54
FT-KV40W	3,600 141.732 (Note 2)	2,000 78.740	810 31.890	860 33.858	400 15.748	260 10.236	420 16.535	210 8.268	140 5.512	P.54
FT-L80Y	3,500 137.795 (Note 2)	1,500 59.055	530 20.866	160 6.299	80 3.150	50 1.969	160 6.299	80 3.150	50 1.969	P.54
FT-R31	290 11.417	130 5.118	49 1.929	45 1.772	23 0.906	15 0.591	24 0.945	12 0.472	8 0.315	P.54
FT-R40	710 27.953	330 12.992	130 5.118	110 4.331	54 2.126	36 1.417	55 2.165	26 1.024	20 0.787	P.54
FT-R41W	710 27.953	330 12.992	130 5.118	110 4.331	50 1.969	30 1.181	56 2.205	28 1.102	20 0.787	P.54
FT-R42W	1,600 62.992	770 30.315	320 12.598	280 11.024	130 5.118	90 3.543	140 5.512	70 2.756	47 1.850	P.54
FT-R43	710 27.953	290 11.417	110 4.331	96 3.780	50 1.969	33 1.299	53 2.087	25 0.984	17 0.669	P.54

Notes: 1) Note that the sensing range of the free-cut type fiber may be reduced by 20 % max. depending upon how the fiber is cut.

2) The fiber cable length practically limits the sensing range.

3) Heat-resistant joint fibers and ordinary-temperature fibers (FT-42) are sold as a set.

4) Sold as a set comprising vacuum type fiber + photo-terminal (FV-BR1) + fiber at atmospheric side (FT-J8).

FIBER SENSORS

LASER SENSORS

PHOTO-ELECTRIC SENSORS

MICRO PHOTO-ELECTRIC SENSORS

AREA SENSORS

LIGHT CURTAINS / SAFETY COMPONENTS

PRESSURE / FLOW SENSORS

INDUCTIVE PROXIMITY SENSORS

PARTICULAR USE SENSORS

SENSOR OPTIONS

SIMPLE WIRE-SAVING UNITS

WIRE-SAVING SYSTEMS

MEASUREMENT SENSORS

STATIC ELECTRICITY PREVENTION DEVICES

LASER MARKERS

PLC

HUMAN MACHINE INTERFACES

ENERGY CONSUMPTION VISUALIZATION COMPONENTS

FA COMPONENTS

MACHINE VISION SYSTEMS

UV CURING SYSTEMS

Selection Guide

Fibers

Fiber Amplifiers

FX-500

FX-100

FX-300

FX-410

FX-311

FX-301-F7/
FX-301-F

LIST OF FIBERS

Thru-beam type (one pair set)



Fibers are listed in alphabetic order. Refer to p.5~ "Fiber Selection" for details of each fiber.

Model No.	Sensing range (mm in) (Note 1)										Dimensions
	Red LED			Blue LED			Green LED				
	LONG	STD	S-D	LONG	STD	FAST	LONG	STD	FAST		
FT-R44Y	710 27.953	290 11.417	110 4.331	96 3.780	50 1.969	33 1.299	53 2.087	25 0.984	17 0.669	P.55	
FT-R60Y	1,800 70.866	830 32.677	350 13.780	250 9.843	120 4.724	80 3.150	140 5.512	70 2.756	50 1.969	P.55	
FT-S11	80 3.150	31 1.220	14 0.551	12 0.472	5 0.197	4 0.157	5 0.197	2.5 0.098	1.5 0.059	P.55	
FT-S20	310 12.205	150 5.906	60 2.362	55 2.165	28 1.102	18 0.709	28 1.102	13 0.512	9 0.354	P.55	
FT-S21	290 11.417	142 5.591	49 1.929	50 1.969	25 0.984	16 0.630	24 0.945	12 0.472	8 0.315	P.55	
FT-S21W	230 9.055	100 3.937	30 1.181	31 1.220	15 0.591	10 0.394	15 0.591	8 0.315	5 0.197	P.55	
FT-S30	900 35.433	450 17.717	180 7.087	155 6.102	76 2.992	45 1.772	90 3.543	40 1.575	26 1.024	P.55	
FT-S31W	710 27.953	330 12.992	130 5.118	110 4.331	50 1.969	30 1.181	56 2.205	28 1.102	20 0.787	P.55	
FT-S32	2,400 94.488	1,100 43.307	510 20.079	420 16.535	200 7.874	130 5.118	220 8.661	100 3.937	72 2.835	P.55	
FT-V23	380 14.961	170 6.693	63 2.480	65 2.559	26 1.024	18 0.709	26 1.024	13 0.512	8 0.315	P.55	
FT-V24W	90 3.543	40 1.575	15 0.591	6 0.236	2 0.079	—	3 0.118	—	—	P.56	
FT-V25	200 7.874	90 3.543	35 1.378	25 0.984	12 0.472	9 0.354	16 0.630	7 0.276	5 0.197	P.56	
FT-V30	420 16.535	200 7.874	70 2.756	80 3.150	40 1.575	22 0.866	40 1.575	14 0.551	8 0.315	P.56	
FT-V40	3,600 141.732 (Note 2)	1,700 66.929	690 27.165	400 15.748	200 7.874	130 5.118	200 7.874	100 3.937	65 2.559	P.56	
FT-V80Y	800 31.496	400 15.748	140 5.512	120 4.724	60 2.362	35 1.378	80 3.150	40 1.575	25 0.984	P.56	
FT-Z20HBW	290 11.417	130 5.118	50 1.969	39 1.535	19 0.748	12 0.472	20 0.787	10 0.394	6 0.236	P.56	
FT-Z20W	570 22.441	250 9.843	90 3.543	82 3.228	37 1.457	23 0.906	44 1.732	18 0.709	11 0.433	P.56	
FT-Z30	1,900 74.803	850 33.465	340 13.386	120 4.724	60 2.362	40 1.575	96 3.780	45 1.772	30 1.181	P.56	
FT-Z30E	3,100 122.047	1,600 62.992	670 26.378	540 21.260	250 9.843	170 6.693	270 10.630	130 5.118	91 3.583	P.56	
FT-Z30EW	2,700 106.299	1,200 47.244	500 19.685	540 21.260	260 10.236	170 6.693	260 10.236	120 4.724	88 3.465	P.57	
FT-Z30H	3,100 122.047	1,600 62.992	670 26.378	650 25.591	310 12.205	200 7.874	340 13.386	160 6.299	110 4.331	P.57	
FT-Z30HW	3,100 122.047	1,500 59.055	610 24.016	540 21.260	260 10.236	170 6.693	260 10.236	120 4.724	88 3.465	P.57	
FT-Z30W	1,400 55.118	640 25.197	260 10.236	83 3.268	40 1.575	25 0.984	73 2.874	36 1.417	25 0.984	P.57	
FT-Z40HBW	710 27.953	330 12.992	130 5.118	110 4.331	50 1.969	30 1.181	56 2.205	28 1.102	20 0.787	P.57	
FT-Z40W	1,300 51.181	630 24.803	260 10.236	180 7.087	90 3.543	60 2.362	90 3.543	50 1.969	35 1.378	P.57	
FT-Z802Y	3,500 137.795	1,500 59.055	530 20.866	320 12.598	160 6.299	120 4.724	160 6.299	80 3.150	60 2.362	P.57	

Notes: 1) Note that the sensing range of the free-cut type fiber may be reduced by 20 % max. depending upon how the fiber is cut.
 2) The fiber cable length practically limits the sensing range.

Selection Guide
 Fibers
 Fiber Amplifiers

FX-500
FX-100
FX-300
FX-410
FX-311
 FX-301-F7/
 FX-301-F

LIST OF FIBERS

Retroreflective type



Fibers are listed in alphabetic order. Refer to p.5~ "Fiber Selection" for details of each fiber.

Model No.	Sensing range (mm in) (Note 1, 2)									Dimensions
	Red LED			Blue LED			Green LED			
	LONG	STD	S-D	LONG	STD	FAST	LONG	STD	FAST	
FR-KZ22E	15 to 330 0.591 to 12.992	15 to 210 0.591 to 8.268	15 to 90 0.591 to 3.543	————	————	————	————	————	————	P.58
FR-KZ50E	20 to 300 0.787 to 11.811	20 to 200 0.787 to 7.874	20 to 200 0.787 to 7.874	20 to 160 0.787 to 6.299	20 to 100 0.787 to 3.937	20 to 60 0.787 to 2.362	20 to 110 0.787 to 4.331	20 to 54 0.787 to 2.126	————	P.58
FR-KZ50H	20 to 300 0.787 to 11.811	20 to 200 0.787 to 7.874	20 to 200 0.787 to 7.874	20 to 140 0.787 to 5.512	20 to 70 0.787 to 2.756	20 to 52 0.787 to 2.047	20 to 90 0.787 to 3.543	20 to 40 0.787 to 1.575	————	P.58
FR-Z50HW	100 to 810 3.937 to 31.890	100 to 580 3.937 to 22.835	100 to 270 3.937 to 10.630	————	————	————	————	————	————	P.58

- Notes: 1) Note that the sensing range of the free-cut type fiber may be reduced by 20 % max. depending upon how the fiber is cut. The sensing range of **FR-KZ22E** is specified for the attached reflector. The sensing range of **FR-KZ50E** and **FR-KZ50H** is specified for the attached reflector **RF-003**. The sensing range of **FR-Z50HW** is specified for the **RF-13**.
- 2) The sensing range is the possible setting range for the attached reflector. The fiber can detect an object less than setting range for the reflector. However, note that if there are any white or highly-reflective surfaces near the fiber head, reflected incident light may affect the fiber head. If this occurs, adjust the threshold value of the amplifier unit before use.

Sensing range when using in combination with FR-Z50HW reflector (Optional)

The sensing ranges are the value for red LED types.

Reflector Model No.	Sensing range (mm in)		
	FX-311		
	LONG	STD	S-D
RF-230	100 to 3,200 3.937 to 125.984	100 to 2,000 3.937 to 78.740	100 to 1,000 3.937 to 39.370
RF-220	100 to 2,400 3.937 to 94.488	100 to 1,300 3.937 to 51.181	100 to 600 3.937 to 23.622
RF-210	100 to 1,700 3.937 to 66.929	100 to 910 3.937 to 35.827	100 to 460 3.937 to 18.110

Note: The sensing range is the possible setting range for the reflector. The fiber can detect an object less than 100 mm 3.937 in. However, note that if there are any white or highly-reflective surfaces near the fiber head, reflected incident light may affect the fiber head. If this occurs, adjust the threshold value of the amplifier unit before use.

- FIBER SENSORS
- LASER SENSORS
- PHOTO-ELECTRIC SENSORS
- MICRO PHOTO-ELECTRIC SENSORS
- AREA SENSORS
- LIGHT CURTAINS / SAFETY COMPONENTS
- PRESSURE / FLOW SENSORS
- INDUCTIVE PROXIMITY SENSORS
- PARTICULAR USE SENSORS
- SENSOR OPTIONS
- SIMPLE WIRE-SAVING UNITS
- WIRE-SAVING SYSTEMS
- MEASURE-MENT SENSORS
- STATIC ELECTRICITY PREVENTION DEVICES
- LASER MARKERS
- PLC
- HUMAN MACHINE INTERFACES
- ENERGY CONSUMPTION VISUALIZATION COMPONENTS
- FA COMPONENTS
- MACHINE VISION SYSTEMS
- UV CURING SYSTEMS

- Selection Guide
- Fibers
- Fiber Amplifiers
- FX-500
- FX-100
- FX-300
- FX-410
- FX-311**
- FX-301-F7/ FX-301-F

FIBER SENSORS

LIST OF FIBERS

Reflective type



Fibers are listed in alphabetic order. Refer to p.5~ "Fiber Selection" for details of each fiber.

Model No.	Sensing range (mm in) (Note 1, 2) / Description										Dimensions
	Red LED			Blue LED			Green LED				
	LONG	STD	S-D	LONG	STD	FAST	LONG	STD	FAST		
FD-30	110 4.331	50 1.969	18 0.709	19 0.748	9 0.354	6 0.236	9 0.354	4.5 0.177	2.5 0.098	P.59	
FD-31	95 3.740	45 1.772	16 0.630	18 0.709	8 0.315	5 0.197	8 0.315	4 0.157	2 0.079	P.59	
FD-31W	40 1.575	20 0.787	10 0.394	7 0.276	4 0.157	1 to 2.5 0.039 to 0.098	5 0.197	1 to 2 0.039 to 0.079	————	P.59	
FD-32G	120 4.724	60 2.362	20 0.787	22 0.866	11 0.433	8 0.315	15 0.591	6 0.236	4 0.157	P.59	
FD-32GX	140 5.512	70 2.756	25 0.984	25 0.984	11 0.433	8 0.315	16 0.630	6 0.236	4 0.157	P.59	
FD-40	110 4.331	50 1.969	18 0.709	19 0.748	9 0.354	6 0.236	9 0.354	4.5 0.177	2.5 0.098	P.59	
FD-41	95 3.740	45 1.772	16 0.630	18 0.709	8 0.315	5 0.197	8 0.315	4 0.157	2 0.079	P.59	
FD-41S	95 3.740	45 1.772	16 0.630	18 0.709	8 0.315	5 0.197	8 0.315	4 0.157	2 0.079	P.59	
FD-41SW	40 1.575	20 0.787	10 0.394	9 0.354	1 to 4 0.039 to 0.157	1 to 2.5 0.039 to 0.098	1 to 4 0.039 to 0.157	1 to 2 0.039 to 0.079	————	P.59	
FD-41W	220 8.661	95 3.740	40 1.575	32 1.260	1 to 15 0.039 to 0.591	1 to 9 0.039 to 0.354	17 0.669	1 to 7.5 0.039 to 0.235	1.5 to 4.5 0.059 to 0.177	P.59	
FD-42G	120 4.724	60 2.362	20 0.787	22 0.866	11 0.433	8 0.315	15 0.591	6 0.236	4 0.157	P.60	
FD-42GW	85 3.346	35 1.378	14 0.551	14 0.551	7 0.276	5 0.197	6 0.236	4 0.157	2 0.079	P.60	
FD-60	350 13.780	160 6.299	70 2.756	55 2.165	28 1.102	18 0.709	30 1.181	15 0.591	10 0.394	P.60	
FD-61	320 12.598	145 5.709	60 2.362	48 1.890	24 0.945	16 0.630	26 1.024	13 0.512	8 0.315	P.60	
FD-61G	200 7.874	90 3.543	40 1.575	46 1.811	23 0.906	15 0.591	26 1.024	12 0.472	8 0.315	P.60	
FD-61S	320 12.598	145 5.709	60 2.362	48 1.890	24 0.945	16 0.630	26 1.024	13 0.512	8 0.315	P.60	
FD-61W	220 8.661	95 3.740	40 1.575	32 1.260	1 to 15 0.039 to 0.591	1 to 9 0.039 to 0.354	17 0.669	1 to 7.5 0.039 to 0.235	1.5 to 4.5 0.059 to 0.177	P.60	
FD-62	480 18.898	220 8.661	90 3.543	80 3.150	1 to 40 0.039 to 1.575	1 to 27 0.039 to 1.063	1 to 42 0.039 to 1.654	1 to 21 0.039 to 0.827	1 to 14 0.039 to 0.551	P.60	
FD-64X	200 7.874	85 3.346	35 1.378	32 1.260	0.5 to 16 0.020 to 0.630	0.5 to 10 0.020 to 0.394	0.5 to 16 0.020 to 0.630	0.5 to 8 0.020 to 0.315	0.5 to 5 0.020 to 0.197	P.61	
FD-A16	200 7.874	150 5.906	50 1.969	19 0.748	14 0.551	————	20 0.787	13 0.512	————	P.61	
FD-AL11	250 9.843	110 4.331	40 1.575	33 1.299	16 0.630	10 0.394	18 0.709	8 0.315	4.5 0.177	P.61	
FD-E13	11 0.433	6 0.236	2 0.079	2 0.079	0.8 0.031	0.5 0.020	0.8 0.031	————	————	P.61	
FD-E23	45 1.772	19 0.748	7 0.276	6 0.236	3 0.118	2 0.079	3 0.118	1.5 0.059	1 0.039	P.61	
FD-EG30	45 1.772	19 0.748	7 0.276	6 0.236	3 0.118	2 0.079	3 0.118	1.5 0.059	1 0.039	P.61	
FD-EG30S	45 1.772	19 0.748	7 0.276	6 0.236	3 0.118	2 0.079	3 0.118	1.5 0.059	1 0.039	P.62	
FD-EG31	15 0.591	8 0.315	3 0.118	2 0.079	1 0.039	0.5 0.020	1 0.039	————	————	P.62	
FD-F4	Applicable pipe diameter: Outer dia. ø6 to ø26 mm ø0.236 to ø1.024 in transparent pipe [PFA (fluorine resin) or equivalently transparent pipe, wall thickness 1 mm 0.039 in]										P.62
FD-F41	Applicable pipe diameter: Outer dia. ø6 to ø26 mm ø0.236 to ø1.024 in transparent pipe [PVC, fluorine resin, polycarbonate, acrylic, glass, wall thickness 1 to 3 mm 0.039 to 0.118 in]										P.62
FD-F41Y (Note 3)	ø4 mm ø0.157 in Protective tube: Fluorine resin, length 500 mm 19.685 in (cuttable) Liquid surface not contacted: Beam received, Liquid surface contacted: Beam interrupted										P.62
FD-F8Y	————	————	————	————	————	————	————	————	————	P.62	
FD-FA93	Applicable pipe diameter: Outer dia. ø8 mm ø0.315 in or more transparent pipe (When used with the tying bands: ø8 to ø80 mm ø0.315 to ø3.150 in) [PFA (fluorine resin), including translucent] Liquid absent: Beam received, Liquid present: Beam interrupted										P.62
FD-H13-FM2	310 12.205	140 5.512	47 1.850	20 0.787	11 0.433	7 0.276	20 0.787	11 0.433	7 0.276	P.63	
FD-H18-L31	0 to 15 0 to 0.591	0 to 10 0 to 0.394	2 to 6 0.079 to 0.236	————	————	————	————	————	————	P.63	
FD-H20-21	270 10.630	140 5.512	47 1.850	36 1.417	18 0.709	12 0.472	20 0.787	10 0.394	7 0.276	P.63	
FD-H20-M1	270 10.630	140 5.512	47 1.850	36 1.417	18 0.709	12 0.472	20 0.787	10 0.394	7 0.276	P.63	
FD-H25-L43 (Note 4)	3 to 25 0.118 to 0.984	4 to 20 0.157 to 0.787	4 to 16 0.157 to 0.630	————	————	————	————	————	————	P.63	
FD-H25-L45 (Note 4)	6 to 41 0.236 to 1.614	7 to 38 0.276 to 1.496	————	————	————	————	————	————	————	P.63	
FD-H30-KZ1V-S (Note 4,5)	20 to 200 0.787 to 7.874	25 to 130 0.984 to 5.118	————	————	————	————	————	————	————	P.64	
FD-H30-L32	0 to 15 0 to 0.591	0 to 10 0 to 0.394	2 to 6 0.079 to 0.236	————	————	————	————	————	————	P.64	
FD-H30-L32V-S (Note 4,5)	0 to 8 0 to 0.315	1.5 to 5 0.059 to 0.197	————	————	————	————	————	————	————	P.64	

Notes: 1) Note that the sensing range of the free-cut type fiber may be reduced by 20 % max. depending upon how the fiber is cut.
 2) The sensing range of reflective type is the value for white non-glossy paper (as for **FD-H30-L32** and **FD-H18-L31** 50 × 50 mm 1.969 × 1.969 in glass substrate).
 3) Liquid inflow prevention joint, protective tube extension joint, fiber mounting joint are available. Please refer to p.38 for details.
 4) The sensing range is specified for transparent glass 100 × 100 × t0.7 mm 3.937 × 3.937 × t0.028 in.
 5) Sold as a set comprising vacuum type fiber + photo-terminal (**FV-BR1**) + fiber at atmospheric side (**FT-J8**).

LIST OF FIBERS

Reflective type



Fibers are listed in alphabetic order. Refer to p.5~ "Fiber Selection" for details of each fiber.

Model No.	Sensing range (mm in) (Note 1, 2) / Description										Dimensions
	Red LED			Blue LED			Green LED				
	LONG	STD	S-D	LONG	STD	FAST	LONG	STD	FAST		
FD-H35-20S	160 6.299	80 3.150	26 1.024	22 0.866	11 0.433	7 0.276	12 0.472	6 0.236	4 0.157		P.64
FD-H35-M2	270 10.630	140 5.512	47 1.850	36 1.417	18 0.709	12 0.472	20 0.787	10 0.394	7 0.276		P.64
FD-H35-M2S6	270 10.630	140 5.512	47 1.850	36 1.417	18 0.709	12 0.472	20 0.787	10 0.394	7 0.276		P.64
FD-HF40Y (Note 3)	ø4 mm ø0.157 in Protective tube: Fluorine resin, length 500 mm 19.685 in (cuttable) Liquid surface not contacted: Beam received, Liquid surface contacted: Beam interrupted										P.64
FD-L10 (Note 4)	0 to 4.5 0 to 0.177	0 to 4 0 to 0.157	0 to 3.5 0 to 0.138	0-3.5 0 to 0.138	0 to 3 0 to 0.118	0.5 to 2.5 0.020 to 0.098	0 to 3 0 to 0.118	1 to 2 0.039 to 0.079	—	—	P.65
FD-L11 (Note 4)	0 to 8 0 to 0.315	0 to 7 0 to 0.906	0 to 6 0 to 0.236	7 0.276	6.5 0.256	0.5 to 5.5 0.020 to 0.217	6.5 0.256	1 to 4 0.039 to 0.157	—	—	P.65
FD-L12W (Note 4)	0.5 to 8 0.019 to 0.315	1 to 5.5 0.039 to 0.217	—	—	—	—	—	—	—	—	P.65
FD-L20H	2 to 23 0.079 to 0.906	4 to 14 0.157 to 0.551	4.8 to 9.5 0.188 to 0.374	4.5 to 10 0.177 to 0.394	5 to 9 0.197 to 0.354	5.5 to 8 0.217 to 0.315	5 to 9 0.197 to 0.354	5.5 to 8 0.217 to 0.315	—	—	P.65
FD-L21 (Note 4)	2 to 18 0.079 to 0.709	3 to 16 0.118 to 0.630	5 to 11 0.197 to 0.433	—	—	—	—	—	—	—	P.65
FD-L21W (Note 4)	3 to 14 0.118 to 0.551	6 to 12 0.236 to 0.472	—	—	—	—	—	—	—	—	P.65
FD-L22A (Note 4)	0 to 23 0 to 0.906	0 to 23 0 to 0.906	1 to 17 0.039 to 0.669	—	—	—	—	—	—	—	P.65
FD-L23 (Note 4)	0 to 30 0 to 1.181	0 to 30 0.039 to 1.181	2 to 27 0.079 to 1.063	—	—	—	—	—	—	—	P.65
FD-L30A (Note 4)	0 to 43 0 to 17.441	0 to 37 0 to 1.457	0 to 26 0 to 1.024	—	—	—	—	—	—	—	P.65
FD-L31A (Note 4)	4 to 33 0.157 to 1.299	5 to 32 0.197 to 1.260	6 to 18 0.236 to 0.709	—	—	—	—	—	—	—	P.65
FD-L32H (Note 4)	0 to 50 0 to 1.969	15 to 35 0.591 to 1.378	—	—	—	—	—	—	—	—	P.66
FD-R31G	92 3.622	44 1.732	17 0.669	17 0.669	8 0.315	5 0.197	8 0.315	4 0.157	2 0.079		P.66
FD-R32EG	45 1.772	19 0.748	7 0.276	6 0.236	3 0.118	1.5 0.059	2 0.079	1 0.039	—	—	P.66
FD-R33EG	15 0.591	6 0.236	2 0.079	2 0.079	0.8 0.031	0.5 0.020	1 0.039	—	—	—	P.66
FD-R34EG	38 1.496	16 0.630	6 0.236	5 0.197	2 0.079	1.5 0.059	2 0.079	1 0.039	—	—	P.66
FD-R41	150 5.906	70 2.756	28 1.102	24 0.945	1 to 13 0.039 to 0.512	1 to 9 0.039 to 0.354	1 to 15 0.039 to 0.591	1 to 8 0.039 to 0.315	3 to 6 0.118 to 0.236		P.66
FD-R60	240 9.449	120 4.724	45 1.772	42 1.654	20 0.787	0.5 to 13 0.020 to 0.512	21 0.827	0.5 to 10 0.020 to 0.394	0.5 to 7 0.020 to 0.276		P.66
FD-R61Y	230 9.055	110 4.331	45 1.771	36 1.417	17 0.669	0.5 to 11 0.020 to 0.433	19 0.748	0.5 to 9 0.020 to 0.354	1 to 6 0.039 to 0.236		P.66
FD-S21	50 1.969	25 0.984	9 0.354	8 0.315	3.5 0.138	2 0.079	5 0.197	2 0.079	1.3 0.051		P.66
FD-S30	110 4.331	50 1.969	18 0.709	19 0.748	9 0.354	6 0.236	9 0.354	4.5 0.177	2.5 0.098		P.67
FD-S31	95 3.740	45 1.772	16 0.630	18 0.709	8 0.315	5 0.197	8 0.315	4 0.157	2 0.079		P.67
FD-S32	270 10.630	140 5.512	55 2.165	48 1.890	24 0.945	16 0.630	26 1.024	13 0.512	8 0.315		P.67
FD-S32W	220 8.661	95 3.740	40 1.575	32 1.260	1 to 15 0.039 to 0.591	1 to 9 0.039 to 0.354	17 0.669	1 to 7.5 0.039 to 0.295	1.5 to 4.5 0.059 to 0.177		P.67
FD-S33GW	85 3.346	35 1.378	14 0.551	14 0.551	7 0.276	5 0.197	6 0.236	4 0.157	2 0.079		P.67
FD-S60Y	360 14.173	170 6.693	70 2.756	50 1.969	20 0.787	3 to 12 0.118 to 0.472	28 1.102	3 to 9 0.118 to 0.354	—	—	P.67
FD-V30	45 1.772	20 0.787	7 0.276	9 0.354	—	—	—	—	—	—	P.67
FD-V30W	15 0.591	7 0.276	—	—	—	—	—	—	—	—	P.67
FD-V50	100 3.937	45 1.772	16 0.630	12 0.472	—	—	6 0.236	—	—	—	P.68
FD-Z20HBW	1 to 70 0.09 to 2.756	2 to 30 0.079 to 1.181	3 to 10 0.118 to 0.394	4 to 10 0.157 to 0.394	—	—	—	—	—	—	P.68
FD-Z20W	1 to 59 0.09 to 2.323	3 to 27 0.118 to 1.063	—	—	—	—	—	—	—	—	P.68
FD-Z40HBW	0.5 to 230 0.02 to 9.055	1 to 100 0.039 to 3.937	1 to 40 0.039 to 1.575	1 to 36 0.039 to 1.417	3 to 17 1.181 to 0.669	3 to 11 1.181 to 0.433	2 to 19 0.079 to 0.748	3 to 8 0.118 to 0.315	4 to 5 0.157 to 0.197		P.68
FD-Z40W	180 7.087	1 to 87 0.039 to 3.425	2.5 to 32 0.098 to 1.260	4 to 20 0.157 to 0.787	—	—	4 to 14 0.157 to 0.551	—	—	—	P.68
FD-Z50HW	10 to 540 0.394 to 21.260	10 to 250 0.393 to 9.843	15 to 100 0.591 to 3.937	—	—	—	—	—	—	—	P.68

Notes: 1) Note that the sensing range of the free-cut type fiber may be reduced by 20 % max. depending upon how the fiber is cut.
 2) The sensing range of reflective type is the value for white non-glossy paper.
 3) Liquid inflow prevention joint, protective tube extension joint, fiber mounting joint are available. Please refer to p.38 for details.
 4) The sensing range is specified for transparent glass 100 × 100 × 0.7 mm 3.937 × 3.937 × 0.028 in (FD-L32H: R edge, FD-L21 and FD-L21W: t2 mm 0.079 in) [FD-L10: silicon wafers 100 × 100 mm 3.937 × 3.937 in].

FIBER SENSORS
LASER SENSORS
PHOTO-ELECTRIC SENSORS
MICRO PHOTO-ELECTRIC SENSORS
AREA SENSORS
LIGHT CURTAINS / SAFETY COMPONENTS
PRESSURE / FLOW SENSORS
INDUCTIVE PROXIMITY SENSORS
PARTICULAR USE SENSORS
SENSOR OPTIONS
SIMPLE WIRE-SAVING UNITS
WIRE-SAVING SYSTEMS
MEASUREMENT SENSORS
STATIC ELECTRICITY PREVENTION DEVICES
LASER MARKERS
PLC
HUMAN MACHINE INTERFACES
ENERGY CONSUMPTION VISUALIZATION COMPONENTS
FA COMPONENTS
MACHINE VISION SYSTEMS
UV CURING SYSTEMS
Selection Guide
Fibers
Fiber Amplifiers

FX-500
FX-100
FX-300
FX-410
FX-311
FX-301-F7 / FX-301-F

FIBER OPTIONS

Refer to p. 69~ for details of lens dimensions.

FIBER SENSORS

LASER SENSORS

PHOTO-ELECTRIC SENSORS

MICRO PHOTO-ELECTRIC SENSORS

AREA SENSORS

LIGHT CURTAINS/SAFETY COMPONENTS

PRESSURE/FLOW SENSORS

INDUCTIVE PROXIMITY SENSORS

PARTICULAR USE SENSORS

SENSOR OPTIONS

SIMPLE WIRE-SAVING UNITS

WIRE-SAVING SYSTEMS

MEASUREMENT SENSORS

STATIC ELECTRICITY PREVENTION DEVICES

LASER MARKERS

PLC

HUMAN MACHINE INTERFACES

ENERGY CONSUMPTION VISUALIZATION COMPONENTS

FA COMPONENTS

MACHINE VISION SYSTEMS

UV CURING SYSTEMS

Selection Guide

Fibers

Fiber Amplifiers

FX-500

FX-100



FX-300

FX-410

FX-311

FX-301-F/
FX-301-F

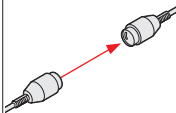
Lens (for thru-beam type fiber)

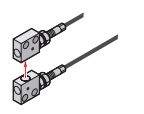
Designation	Model No.	Description
For thru-beam type fiber	Expansion lens (Note 1) FX-LE1	 <p>Increases the sensing range by 5 times or more.</p> <ul style="list-style-type: none"> Ambient temperature: -60 to +350 °C -76 to +662 °F (Note 5) Beam dia: ø3.6 mm ø0.142 in
	Super-expansion lens (Note 1) FX-LE2	 <p>Tremendously increases the sensing range with large diameter lenses.</p> <ul style="list-style-type: none"> Ambient temperature: -60 to +350 °C -76 to +662 °F (Note 5) Beam dia: ø9.8 mm ø0.386 in
	Side-view lens FX-SV1	 <p>Beam axis is bent by 90°.</p> <ul style="list-style-type: none"> Ambient temperature: -60 to +300 °C -76 to +572 °F (Note 5) Beam dia: ø2.8 mm ø0.110 in
	Expansion lens for vacuum fiber (Note 1) FV-LE1	 <p>Sensing range increases by 4 times or more.</p> <ul style="list-style-type: none"> Ambient temperature: -60 to +350 °C -76 to +662 °F (Note 5) Beam dia: ø3.6 mm ø0.142 in
Vacuum resistant side-view lens (Note 1) FV-SV2	 <p>Beam axis is bent by 90°.</p> <ul style="list-style-type: none"> Ambient temperature: -60 to +300 °C -76 to +572 °F (Note 5) Beam dia: ø3.7 mm ø0.146 in 	

Sensing range for red LED type (mm) [Lens on both sides] (Note 2)

Mode Fiber	LONG	STD	S-D
FT-43	3,600 141.732	2,900 114.173	1,300 51.181
FT-42	3,600 141.732	3,600 141.732	1,600 62.992
FT-45X	1,600 62.992	1,600 62.992	1,600 62.992
FT-R40	3,600 141.732	3,400 133.858	1,500 59.055
FT-H35-M2	3,500 137.795 (Note 3)	2,000 78.740	750 29.528
FT-H20W-M1	1,600 62.992 (Note 3)	1,300 51.181	500 19.685
FT-H20-M1	1,600 62.992 (Note 3)	1,600 62.992 (Note 3)	900 35.433

Sensing range for red LED type (mm) [Lens on both sides] (Note 2)

Mode Fiber	LONG	STD	S-D
FT-43	3,600 141.732	3,600 141.732	3,600 141.732
FT-42	3,600 141.732	3,600 141.732	3,600 141.732
FT-45X	1,600 62.992	1,600 62.992	1,600 62.992
FT-R40	3,600 141.732	3,600 141.732	3,600 141.732
FT-H35-M2	3,500 137.795 (Note 3)	3,500 137.795 (Note 3)	3,500 137.795 (Note 3)
FT-H20W-M1	1,600 62.992 (Note 3)	1,600 62.992 (Note 3)	1,500 59.055
FT-H20-M1	1,600 62.992 (Note 3)	1,600 62.992 (Note 3)	1,600 62.992 (Note 3)
FT-H13-FM2	3,500 137.795 (Note 3)	3,500 137.795 (Note 3)	3,500 137.795 (Note 3)

Sensing range for red LED type (mm) [Lens on both sides] (Note 2)

Mode Fiber	LONG	STD	S-D
FT-43	1,200 47.244	580 22.835	250 9.843
FT-42	1,400 55.118	640 25.197	210 8.268
FT-45X	1,600 62.992	650 25.591	220 8.661
FT-H35-M2	550 21.654	280 11.024	90 3.543
FT-H20W-M1	310 12.205	140 5.512	50 1.969
FT-H20-M1	550 21.654	280 11.024	90 3.543

Sensing range for red LED type (mm) [Lens on both sides] (Note 2, 4)

Mode Fiber	LONG	STD	S-D
FT-H30-M1V-S	1,200 47.244	450 17.717	150 5.906

Sensing range for red LED type (mm) [Lens on both sides] (Note 2, 4)

Mode Fiber	LONG	STD	S-D
FT-H30-M1V-S	1,200 47.244	450 17.717	150 5.906

- Notes: 1) Be careful sure to use it only after you have adjusted it sufficiently when installing the thru-beam type fiber equipped with the expansion lens, as the beam envelope becomes narrow and alignment is difficult.
 2) The sensing ranges are the values for red LED type amplifier. Please contact our office for details on sensing type ranges for other types of amplifiers.
 3) The fiber cable length practically limits the sensing range.
 4) The fiber cable length for the FT-H30-M1V-S is 1 m 3.281 ft. The sensing ranges in LONG modes take into account the length of the FT-J8 atmospheric side fiber.
 5) Refer to p.15, p.18, p.33 and p.35 for the ambient temperatures of fibers to be used in combination.

FIBER OPTIONS

Refer to p. 69~ for details of lens dimensions.

Lens (for reflective type fiber)

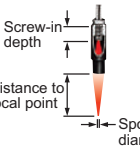
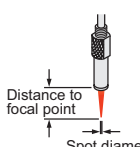
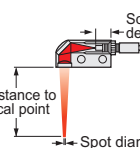
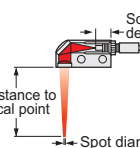
Designation	Model No.	Description	
For reflective type fiber	Pinpoint spot lens FX-MR1		Pinpoint spot of $\phi 0.5$ mm $\phi 0.020$ in. Enables detection of minute objects or small marks. • Distance to focal point: 6 ± 1 mm 0.236 ± 0.039 in • Applicable fibers: FD-42G, FD-42GW • Ambient temperature: -40 to $+70$ °C -40 to $+158$ °F (Note)
	Zoom lens FX-MR2		The spot diameter is adjustable from $\phi 0.7$ to $\phi 2$ mm $\phi 0.028$ to $\phi 0.079$ in according to how much the fiber is screwed in. • Applicable fibers: FD-42G, FD-42GW • Ambient temperature: -40 to $+70$ °C -40 to $+158$ °F (Note 2) • Accessory: MS-EX3 (mounting bracket)
	Finest spot lens FX-MR3		Extremely fine spot of $\phi 0.15$ mm $\phi 0.006$ in approx. achieved. • Applicable fibers: FD-EG31, FD-EG30, FD-42G, FD-42GW, FD-32G, FD-32GX • Ambient temperature: -40 to $+70$ °C -40 to $+158$ °F (Note 2)
	Finest spot lens FX-MR6		Extremely fine spot of $\phi 0.1$ mm $\phi 0.004$ in approx. achieved. • Applicable fibers: FD-EG31, FD-EG30, FD-42G, FD-42GW, FD-32G, FD-32GX • Ambient temperature: -20 to $+60$ °C -4 to $+140$ °F (Note 2)
	Zoom lens side-view type FX-MR5		FX-MR2 is converted into a side-view type and can be mounted in a very small space. • Applicable fibers: FD-42G, FD-42GW • Ambient temperature: -40 to $+70$ °C -40 to $+158$ °F (Note 2)

Sensing range for red LED type (Note 1)

Screw-in depth	Distance to focal point	Spot diameter
7 mm	18.5 mm approx.	$\phi 0.7$ mm
12 mm	27 mm approx.	$\phi 1.2$ mm
14 mm	43 mm approx.	$\phi 2.0$ mm

Sensing range for red LED type (Note 1)

Fiber model No.	Distance to focal point	Spot diameter
FD-EG31	7.5 ± 0.5 mm	$\phi 0.15$ mm approx.
FD-EG30	7.5 ± 0.5 mm	$\phi 0.3$ mm approx.
FD-42G/42GW FD-32G/32GX	7.5 ± 0.5 mm	$\phi 0.5$ mm approx.

Sensing range for red LED type (Note 1)







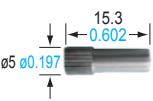
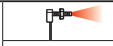

Fiber model No.	Distance to focal point	Spot diameter
FD-EG31	7 ± 0.5 mm	$\phi 0.1$ mm approx.
FD-EG30	7 ± 0.5 mm	$\phi 0.2$ mm approx.
FD-42G/42GW FD-32G/32GX	7 ± 0.5 mm	$\phi 0.4$ mm approx.

Sensing range for red LED type (Note 1)

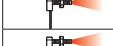
Screw-in depth	Distance to focal point	Spot diameter
8 mm	13 mm approx.	$\phi 0.5$ mm
10 mm	15 mm approx.	$\phi 0.8$ mm
14 mm	30 mm approx.	$\phi 3.0$ mm

Notes: 1) The sensing ranges are the values when used in combination with a red LED type amplifier. Please contact our office for details on sensing ranges for other types of amplifier.
2) Refer to p.16 or p.26 for the ambient temperatures of fibers to be used in combination.

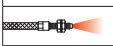
Lens (For square head M3 reflective fiber)

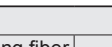
Type	Spot diameter (mm in)	Distance to focal point (mm in)	Lens		Fiber		
			Shape (mm in)	Model No.	Shape	Emitting fiber core (mm in)	Model No.
For Square head M3 reflective fiber	Finest spot lens	7 ± 0.5 0.276 ± 0.020		FX-MR7		$\phi 0.125 \phi 0.005$	FD-R33EG
						$\phi 0.125 \phi 0.005$	FD-EG31
						$\phi 0.175 \phi 0.007$	FD-R34EG
						$\phi 0.25 \phi 0.010$	FD-R32EG
						$\phi 0.25 \phi 0.010$	FD-EG30
	$\phi 0.4 \phi 0.016$ approx.					$\phi 0.5 \phi 0.020$	FD-R31G
					$\phi 0.5 \phi 0.020$	FD-32G	
					$\phi 0.5 \phi 0.020$	FD-32GX	
					$\phi 0.5 \phi 0.020$	FD-42G	
						$\phi 0.5 \phi 0.020$	FD-42GW

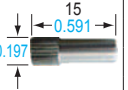
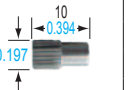
Type	Spot diameter (mm in)	Sensing range (mm in)	Lens		Applicable fibers	
			Shape (mm in)	Model No.	Emitting fiber core (mm in)	Model No.
For Square head M3 reflective fiber	Zoom lens	10 to 30 0.394 to 1.181		FX-MR8	$\phi 0.125 \phi 0.005$	FD-R33EG, FD-EG31
					$\phi 0.175 \phi 0.007$	FD-R34EG
					$\phi 0.25 \phi 0.010$	FD-R32EG, FD-EG30
					$\phi 0.5 \phi 0.020$	FD-R31G, FD-32G, FD-32GX, FD-42G, FD-42GW
	Parallel light lens	$\phi 4.0 \phi 0.157$ approx.	0 to 30 0 to 1.181		FX-MR9	$\phi 0.125 \phi 0.005$
					$\phi 0.175 \phi 0.007$	FD-R34EG
					$\phi 0.25 \phi 0.010$	FD-R32EG, FD-EG30
					$\phi 0.5 \phi 0.020$	FD-R31G, FD-32G, FD-32GX, FD-42G, FD-42GW

Note: Spot diameter, distance to focal point and sensing range are specified for a red LED type amplifier.

FIBER SENSORS

LASER SENSORS

PHOTO-ELECTRIC SENSORS

MICRO PHOTO-ELECTRIC SENSORS

AREA SENSORS

LIGHT CURTAINS/SAFETY COMPONENTS

PRESSURE/FLOW SENSORS

INDUCTIVE PROXIMITY SENSORS

PARTICULAR USE SENSORS

SENSOR OPTIONS

SIMPLE WIRE-SAVING UNITS

WIRE-SAVING SYSTEMS

MEASUREMENT SENSORS

STATIC ELECTRICITY PREVENTION DEVICES

LASER MARKERS

PLC

HUMAN MACHINE INTERFACES

ENERGY CONSUMPTION VISUALIZATION COMPONENTS

FA COMPONENTS

MACHINE VISION SYSTEMS

UV CURING SYSTEMS

Selection Guide

Fibers

Fiber Amplifiers

FX-500

FX-100

FX-300

FX-410

FX-311

FX-301-F7/
FX-301-F

FIBER SENSORS

FIBER OPTIONS

- LASER SENSORS
- PHOTO-ELECTRIC SENSORS
- MICRO PHOTO-ELECTRIC SENSORS
- AREA SENSORS
- LIGHT CURTAINS/SAFETY COMPONENTS
- PRESSURE/FLOW SENSORS
- INDUCTIVE PROXIMITY SENSORS
- PARTICULAR USE SENSORS
- SENSOR OPTIONS
- SIMPLE WIRE-SAVING UNITS
- WIRE-SAVING SYSTEMS
- MEASUREMENT SENSORS
- STATIC ELECTRICITY PREVENTION DEVICES
- LASER MARKERS
- PLC
- HUMAN MACHINE INTERFACES
- ENERGY CONSUMPTION VISUALIZATION COMPONENTS
- FA COMPONENTS
- MACHINE VISION SYSTEMS
- UV CURING SYSTEMS

Others

Designation	Model No.	Description			
Protective tube for thru-beam type fiber	FTP-500 (0.5 m 1.640 ft)	For M4 thread	FT-42 FT-42S FT-42W	FT-43 FT-H13-FM2	
	FTP-1000 (1 m 3.281 ft)		Applicable fibers	The protective tube, made of non-corrosive stainless steel, protects the inner fiber cable from any external forces.	
	FTP-1500 (1.5 m 4.921 ft)				
	FTP-N500 (0.5 m 1.640 ft)	For M3 thread			FT-31 FT-31S FT-31W
	FTP-N1000 (1 m 3.281 ft)		For M6 thread	FD-61 FD-61G FD-61S FD-61W	FD-H13-FM2
	FTP-N1500 (1.5 m 4.921 ft)				
Protective tube for reflective type fiber	FDP-500 (0.5 m 1.640 ft)	For M6 thread	FD-41 FD-41W	FD-41S FD-41SW	
	FDP-1000 (1 m 3.281 ft)				
	FDP-1500 (1.5 m 4.921 ft)	For M4 thread			
	FDP-N500 (0.5 m 1.640 ft)				
	FDP-N1000 (1 m 3.281 ft)				
	FDP-N1500 (1.5 m 4.921 ft)				
Fiber bender	FB-1	The fiber bender bends the sleeve part of the fiber head at the proper radius. (Note 1)			
Universal sensor mounting stand (Note 2)	MS-AJ1-F	Horizontal mounting type	Mounting stand assembly for fiber (For M3, M4 or M6 threaded head fiber)		
	MS-AJ2-F	Vertical mounting type			
Liquid inflow prevention joint (Note 2)	MS-FX-01Y	Applicable fibers	This joint suppresses false operations due to liquid slip-in from the top of the protective tube.		
Protective tube extension joint (Note 2)	MS-FX-02Y		The protective tube can be extended.		
Fiber mounting joint (Note 2)	MS-FX-03Y		The joint is used for mounting fibers on a tank.		
Single core holder	FX-AT15A	The incident light intensity may vary when using a multi-core fiber or a thin type sharp bending fiber. This holder suppresses the variation in the incident light intensity. (Brown)			
Reflector	RF-210	Used with FR-Z50HW .			
	RF-220	Refer to p.30 or p.41 for the sensing range of FR-Z50HW to be used in combination.			
	RF-230				

Notes: 1) Do not bend the sleeve part of any side-view type fiber or ultra-small diameter head type fiber.
 2) The joint internal ferrule (MS-FX-YF) is available as a spare part. A distorted ferrule may result in leakage.

Protective tube

- FTP-□
- FDP-□

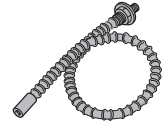

Fiber bender

- FB-1

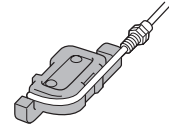

Universal sensor mounting stand

Using the arm which enables adjustment in the horizontal direction, sensing can also be done from above an assembly line.

- MS-AJ1-F

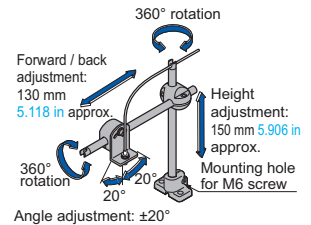

- MS-AJ2-F

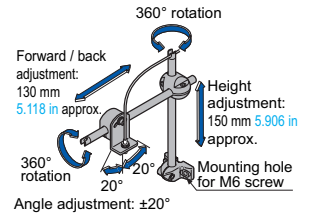

Single core holder

- FX-AT15A



- Selection Guide
- Fibers
- Fiber Amplifiers
- FX-500
- FX-100
- FX-300
- FX-410
- FX-311**
- FX-301-F7/ FX-301-F

Liquid inflow prevention joint

- MS-FX-01Y

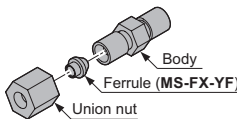

Protective tube extension joint

- MS-FX-02Y

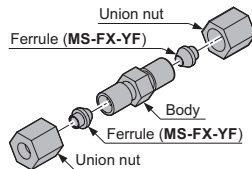

Fiber mounting joint

- MS-FX-03Y

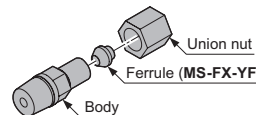

Reflector

- RF-210

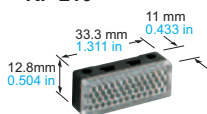

- RF-220

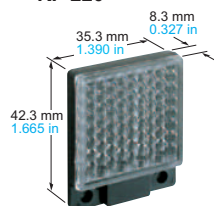

- RF-230

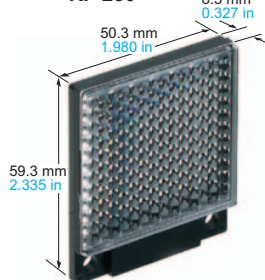

SPECIFICATIONS

Amplifiers

Item	Type Model No.	NPN output			PNP output		
		Red LED FX-311	Blue LED FX-311B	Green LED FX-311G	Red LED FX-311P	Blue LED FX-311BP	Green LED FX-311GP
Supply voltage	12 to 24 V DC ±10 % Ripple P-P 10 % or less						
Power consumption	840 mW or less (Current consumption 35 mA or less at 24 V supply voltage)						
Output	NPN open-collector transistor • Maximum sink current: 100 mA (50 mA, if five, or more, amplifiers are connected in cascade) • Applied voltage: 30 V DC or less (between output and 0 V) • Residual voltage: 1.5 V or less [at 100 mA sink current (50 mA, if five, or more, amplifiers are connected in cascade)]			PNP open-collector transistor • Maximum source current: 100 mA (50 mA, if five, or more, amplifiers are connected in cascade) • Applied voltage: 30 V DC or less (between output and +V) • Residual voltage: 1.5 V or less [at 100 mA sink current (50 mA, if five, or more, amplifiers are connected in cascade)]			
Utilization category	DC-12 or DC-13						
Output operation	Selectable either Light-ON or Dark-ON, with selection switch						
Short-circuit protection	Incorporated						
Response time	<Red LED type> 250 μs or less (STD / S-D), 2 ms or less (LONG) selectable with selection switch			<Blue LED type / Green LED type> 150 μs or less (FAST), 250 μs or less (STD), 2 ms or less (LONG) selectable with selection switch			
Operation indicator	Orange LED (lights up when the output is ON)						
Stability indicator	Green LED (lights up under stable light received condition or stable dark condition)						
Sensitivity adjuster	12-turn potentiometer with indicator (Pointer part: red backlight) (Note 2)						
Timer function	Incorporated with OFF-delay timer, selectable either effective (approx. 10 ms or 40 ms) or ineffective						
Automatic interference prevention function	Incorporated (Up to 4 sets of fiber heads can be mounted close together.) (Note 3)						
Environmental resistance	Pollution degree	3 (Industrial environment)					
	Ambient temperature	-10 to +55 °C -14 to +131 °F (If 4 to 7 units are connected in cascade: -10 to +50 °C +14 to +122 °F, if 8 to 16 units are connected in cascade: -10 to +45 °C +14 to +113 °F) (No dew condensation or icing allowed), Storage: -20 to +70 °C -4 to +158 °F					
	Ambient humidity	35 to 85 % RH, Storage: 35 to 85 % RH					
	Ambient illuminance	Incandescent light: 3,000 lx at the light-receiving face					
	EMC	EN 60947-5-2					
	Voltage withstandability	1,000 V AC for one min. between all supply terminals connected together and enclosure (Note 4)					
	Insulation resistance	20 MΩ, or more, with 250 V DC megger between all supply terminals connected together and enclosure (Note 4)					
	Vibration resistance	10 to 150 Hz frequency, 0.75 mm 0.03 in amplitude in X, Y and Z directions for two hours each					
Shock resistance	98 m/s ² acceleration (10 G approx.) in X, Y and Z directions for five times each						
Emitting element (modulated)	Red LED	Blue LED	Green LED	Red LED	Blue LED	Green LED	
Peak emission wavelength	650 nm 0.026 mil	470 nm 0.019 mil	525 nm 0.021 mil	650 nm 0.026 mil	470 nm 0.019 mil	525 nm 0.021 mil	
Material	Enclosure: Heat-resistant ABS, Case cover: Polycarbonate						
Connecting method	Connector (Note 5)						
Cable length	Total length up to 100 m 328.084 ft is possible with 0.3 mm ² , or more, cable.						
Weight	Net weight: 15 g approx., Gross weight: 20 g approx.						

- Notes: 1) Where measurement conditions have not been specified precisely, the conditions used were an ambient temperature of +23 °C **+73.4 °F**.
 2) The red backlight of the pointer part lights up more brightly when the power is turned ON and when the sensitivity is adjusted.
 3) When the power supply is switched on, the emission timing are automatically set for interference prevention.
 4) The voltage withstandability and the insulation resistance values given in the above table are for the amplifier only.
 5) The cable for amplifier connection is not supplied as an accessory. Make sure to use the optional quick-connection cable given below.
 Main cable (3-core): **CN-73-C1** (cable length 1 m **3.281 ft**), **CN-73-C2** (cable length 2 m **6.562 ft**), **CN-73-C5** (cable length 5 m **16.404 ft**)
 Sub cable (1-core): **CN-71-C1** (cable length 1 m **3.281 ft**), **CN-71-C2** (cable length 2 m **6.562 ft**), **CN-71-C5** (cable length 5 m **16.404 ft**)

FIBER SENSORS

LASER SENSORS

PHOTO-ELECTRIC SENSORS

MICRO PHOTO-ELECTRIC SENSORS

AREA SENSORS

LIGHT CURTAINS / SAFETY COMPONENTS

PRESSURE / FLOW SENSORS

INDUCTIVE PROXIMITY SENSORS

PARTICULAR USE SENSORS

SENSOR OPTIONS

SIMPLE WIRE-SAVING UNITS

WIRE-SAVING SYSTEMS

MEASUREMENT SENSORS

STATIC ELECTRICITY PREVENTION DEVICES

LASER MARKERS

PLC

HUMAN MACHINE INTERFACES

ENERGY CONSUMPTION VISUALIZATION COMPONENTS

FA COMPONENTS

MACHINE VISION SYSTEMS

UV CURING SYSTEMS

Selection Guide

Fibers

Fiber Amplifiers

FX-500

FX-100

FX-300

FX-410

FX-311

FX-301-F7/

FX-301-F

FIBER SENSORS

I/O CIRCUIT AND WIRING DIAGRAMS

LASER SENSORS

FX-311□

NPN output type

I/O circuit diagram

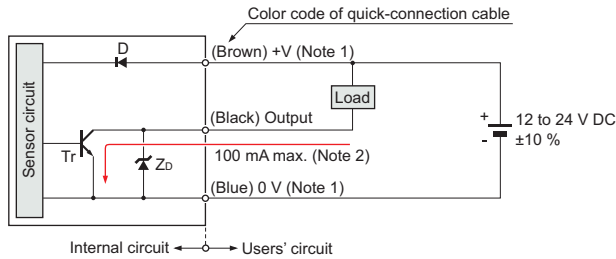

Notes: 1) The quick-connection sub cable does not have +V (brown) and 0 V (blue). The power is supplied from the connector of the main cable.
2) 50 mA max., if five amplifiers, or more, are connected together.

Symbols ... D : Reverse supply polarity protection diode
Zd : Surge absorption zener diode
Tr : NPN output transistor

Wiring diagram

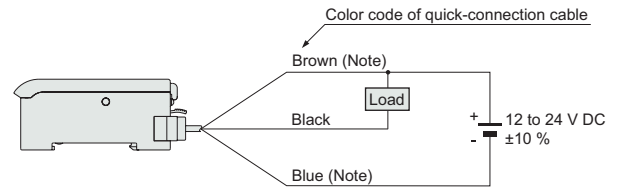

Note: The quick-connection sub cable does not have brown lead wire and blue lead wire. The power is supplied from the connector of the main cable.

Terminal arrangement diagram

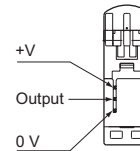

PHOTO-ELECTRIC SENSORS

MICRO PHOTO-ELECTRIC SENSORS

AREA SENSORS

LIGHT CURTAINS/SAFETY COMPONENTS

PRESSURE/FLOW SENSORS

INDUCTIVE PROXIMITY SENSORS

PARTICULAR USE SENSORS

SENSOR OPTIONS

SIMPLE WIRE-SAVING UNITS

WIRE SAVING SYSTEMS

MEASUREMENT SENSORS

STATIC ELECTRICITY PREVENTION DEVICES

LASER MARKERS

PLC

HUMAN MACHINE INTERFACES

ENERGY CONSUMPTION VISUALIZATION COMPONENTS

FA COMPONENTS

MACHINE VISION SYSTEMS

UV CURING SYSTEMS

FX-311□P

PNP output type

I/O circuit diagram

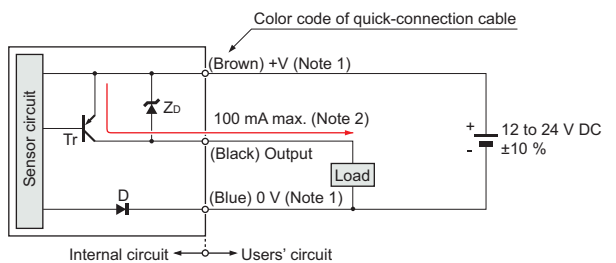

Notes: 1) The quick-connection sub cable does not have +V (brown) and 0 V (blue). The power is supplied from the connector of the main cable.
2) 50 mA max., if five amplifiers, or more, are connected together.

Symbols ... D : Reverse supply polarity protection diode
Zd : Surge absorption zener diode
Tr : PNP output transistor

Wiring diagram

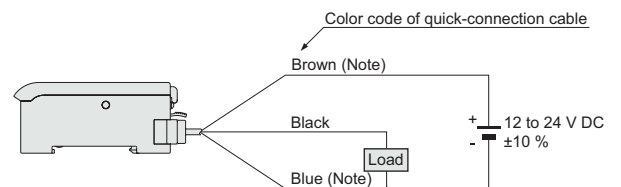

Note: The quick-connection sub cable does not have brown lead wire and blue lead wire. The power is supplied from the connector of the main cable.

Terminal arrangement diagram

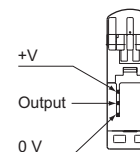

Selection Guide

Fibers

Fiber Amplifiers

FX-500

FX-100

FX-300

FX-410

FX-311

FX-301-F7/
FX-301-F

PRECAUTIONS FOR PROPER USE

Refer to p.1458~ for general precautions.



- Never use this product as a sensing device for personnel protection.
- In case of using sensing devices for personnel protection, use products which meet laws and standards, such as OSHA, ANSI or IEC etc., for personnel protection applicable in each region or country.

Part description

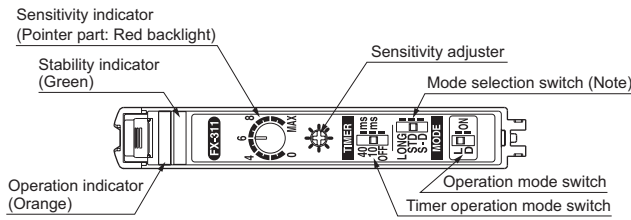

Note: The mode selected by the mode selection switch for **FX-311B(P)** and **FX-311G(P)** is 'LONG', 'STD' or 'FAST'.

Amplifier of cascading

- Make sure that the power supply is off while adding or removing the amplifiers.
- Make sure to check the allowable ambient temperature, as it depends on the number of amplifiers connected in cascade.
- In case two, or more, amplifiers are connected in cascade, make sure to mount them on a DIN rail.
- When the amplifiers move on the DIN rail depending on the attaching condition, fitting them between the optional end plates (**MS-DIN-E**) mounted at the two ends.
- When connecting in cascade, mount the amplifiers close to each other, fitting them between the optional end plates (**MS-DIN-E**) mounted at the two ends.
- Up to maximum 15 amplifiers can be added (total 16 amplifiers connected in cascade.)
- When connecting more than two amplifiers in cascade, use the sub cable (**CN-71-C□**) as the quick-connection cable for the second amplifier onwards.
- The settings other than the interference prevention function cannot be transmitted between this product and other digital fiber amplifiers. Therefore, in case both models of amplifiers are mounted in cascade, be sure to mount identical models together.
For more details, refer to “**Cautions on sensor connection in cascade**” (p.159).

Timer function

- This product incorporates an OFF-delay timer function. The delay time can be selected as either 10 ms. approx. or 40 ms. approx. with the timer selection switch. Since the output is extended by a fixed period, it is useful when the connected device has a slow response time or when small objects are being sensed and the output signal width is small.

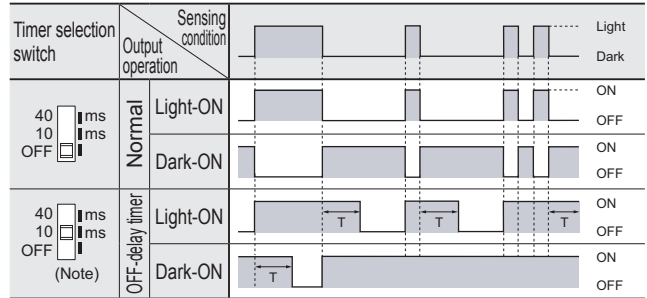

Delay time T: 10 ms approx. (when set to 10 ms),
40 ms approx. (when set to 40 ms)

Note: The diagram shows the case when 10 ms delay time is selected.

Automatic interference prevention function

- This product incorporates an automatic interference prevention function. If the amplifiers are mounted in cascade, since a different emission timing is automatically set for up to 4 amplifiers, up to 4 sets of fibers can be mounted closely. Further, even if the amplifiers are mounted closely along with the digital fiber sensor **FX-300** series, the interference prevention function works. However, in case both models of amplifiers are mounted in cascade, mount identical models together.

Wiring

- Make sure that the power supply is off while wiring.
- Verify that the supply voltage variation is within the rating.
- Take care that if a voltage exceeding the rated range is applied, or if an AC power supply is directly connected, the product may get burnt or damaged.
- If power is supplied from a commercial switching regulator, ensure that the frame ground (F.G.) terminal of the power supply is connected to an actual ground.
- In case noise generating equipment (switching regulator, inverter motor, etc.) is used in the vicinity of this product, connect the frame ground (F.G.) terminal of the equipment to an actual ground.
- Take care that short circuit of the load wrong wiring may burn or damage the product.
- Do not run the wires together with high-voltage lines or power lines or put them in the same raceway. This can cause malfunction due to induction.
- Make sure to use an isolation transformer for the DC power supply. If an autotransformer (single winding transformer) is used, this product or the power supply may get damaged.
- Make sure to use the optional quick-connection cable for the connection of the amplifier. Extension up to total 100 m **328.084 ft** is possible with 0.3 mm², or more, cable. However, in order to reduce noise, make the wiring as short as possible.

FIBER SENSORS

LASER SENSORS

PHOTO-ELECTRIC SENSORS

MICRO PHOTO-ELECTRIC SENSORS

AREA SENSORS

LIGHT CURTAINS / SAFETY COMPONENTS

PRESSURE / FLOW SENSORS

INDUCTIVE PROXIMITY SENSORS

PARTICULAR USE SENSORS

SENSOR OPTIONS

SIMPLE WIRE-SAVING UNITS

WIRE-SAVING SYSTEMS

MEASUREMENT SENSORS

STATIC ELECTRICITY PREVENTION DEVICES

LASER MARKERS

PLC

HUMAN MACHINE INTERFACES

ENERGY CONSUMPTION VISUALIZATION COMPONENTS

FA COMPONENTS

MACHINE VISION SYSTEMS

UV CURING SYSTEMS

Selection Guide

Fibers

Fiber Amplifiers

FX-500

FX-100

FX-300

FX-410

FX-311

FX-301-F7/

FX-301-F

PRECAUTIONS FOR PROPER USE

Refer to p.1458~ for general precautions.

- FIBER SENSORS
- LASER SENSORS
- PHOTO-ELECTRIC SENSORS
- MICRO PHOTO-ELECTRIC SENSORS
- AREA SENSORS
- LIGHT CURTAINS/ SAFETY COMPONENTS
- PRESSURE / FLOW SENSORS
- INDUCTIVE PROXIMITY SENSORS
- PARTICULAR USE SENSORS
- SENSOR OPTIONS
- SIMPLE WIRE-SAVING UNITS
- WIRE-SAVING SYSTEMS
- MEASUREMENT SENSORS
- STATIC ELECTRICITY PREVENTION DEVICES
- LASER MARKERS
- PLC
- HUMAN MACHINE INTERFACES
- ENERGY CONSUMPTION VISUALIZATION COMPONENTS
- FA COMPONENTS
- MACHINE VISION SYSTEMS
- UV CURING SYSTEMS
- Selection Guide
- Fibers
- Fiber Amplifiers
- FX-500
- FX-100
- FX-300
- FX-410
- FX-311**
- FX-301-F7/ FX-301-F

Operation procedure

- For **FX-311(P)**, the most suitable sensing mode can be selected according to the application from LONG (long range distance), STD (standard) or S-D (reduced intensity). Furthermore, for **FX-311B(P)** and **FX-311G(P)**, the sensing mode can be selected from LONG (long range distance), STD (standard) or FAST (high speed sensing).

Mode selection switch		Applications	Response time
FX-311(P)	FX-311B(P)/311G(P)		
LONG STD S-D	LONG STD FAST	Used in case long distance sensing is required. (However, the response time is longer than in STD mode.)	2 ms
LONG STD S-D	LONG STD FAST	Used for general sensing application.	250 μs
—	LONG STD FAST	Used in case high speed sensing is required.	150 μs
LONG STD S-D	—	Since the emitted light amount is restricted in this mode, it is suitable for delicate sensing, such as when the received light is saturated due to too short a sensing distance or when detecting translucent objects, etc.	250 μs

Note: Make sure to carry out sensitivity adjustment after mode setting.

Sensitivity adjustment

- Adjust the sensitivity, observing the operation indicator (orange). However, since the condition for lighting up of the indicator depends on the combination of the sensing condition and the selected operation of L/D-ON, verify it from the table below.

Sensing condition	Operation	Operation indicator
Light	L-ON (Light-ON)	☉
	D-ON (Dark-ON)	●
Dark	L-ON (Light-ON)	●
	D-ON (Dark-ON)	☉

☉ : Lights up ● : Turns off

- The sensitivity adjuster is a 12-turn potentiometer. The maximum sensitivity is obtained by turning it fully clockwise.
- The pointer shows the present sensitivity level.

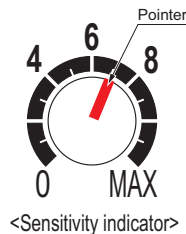

Assist function

- This product incorporates an “assist function”, which helps to easily search the optimum sensitivity position by flashing of the pointer. In order to make “assist function” effective, switch the operation selection switch in the order L-ON (Light ON) → D-ON (Dark ON) → L-ON (Light ON).

- Notes:
- “Assist function” cannot be used when adjusting sensitivity for moving objects.
 - “Assist function” turns off automatically once the sensitivity adjustment has been completed.
 - In case “assist function” is not to be used, set the operation selection switch to D-ON (Dark ON) and wait for 2 sec., or more, to make “assist function” ineffective.

Step	Sensing method		Operation	Sensitivity indicator
	Reflective type	Thru-beam type		
①	Make sure that the operation selection switch is set to L-ON (Light ON). In case “assist function” is to be used, switch the operation selection switch in the order of L-ON (Light ON) → D-ON (Dark ON) → L-ON (Light ON).		Turn the sensitivity adjuster fully counterclockwise. (Minimum sensitivity)	
②			In the beam received condition, slowly turn the adjuster clockwise and find the point (A) where the sensor is switched ON. The pointer flashes once at the point (A). (Note 1)	
③			In the beam not received condition, slowly turn the adjuster further clockwise until the sensor goes into the ON state again. Once it is switched on, turn the adjuster counterclockwise a little and find the point (B) where it is switched OFF. The pointer flashes twice at the point (B). (Note 2) (If the sensor does not go into the ON state, MAX is the point (B).)	
④	—	—	Turn the adjuster towards the point (A) from the point (B) slowly. The pointer starts flashing when it approaches the optimum sensitivity point and flashes faster at the optimum sensitivity point for 3 sec. This point is the optimum sensitivity point. (Note 2)	
⑤	Select either L-ON (Light ON) or D-ON (Dark ON) according to your application.			

- Notes:
- When “assist function” is not used, the pointer does not flash.
 - When “assist function” is not used, the middle point of (A) and (B) is regarded as the optimum sensitivity point.
 - In order to protect the mechanism, the sensitivity adjuster idles when over turned, which may result in a backlash of 1 to 2 divisions.
 - Depending upon the sensing conditions, stable sensing may be possible at a position which is slightly shifted from the optimum sensitivity point.
 - Do not move or bend the fiber cable after the sensitivity adjustment. Detection may become unstable.

Others

- Do not use during the initial transient time (0.5 sec. approx.) after the power supply is switched on.
- Take care that the sensor is not directly exposed to fluorescent lamp from a rapid-starter lamp, a high frequency lighting device or sunlight etc., as it may affect the sensing performance.
- This sensor is suitable for indoor use only.
- Do not use this sensor in places having excessive vapor, dust, etc., or where it may come in contact with corrosive gas.
- Take care that the sensor does not come in contact with water, oil, grease, organic solvents, such as, thinner etc., or strong acid, and alkaline.
- This sensor cannot be used in an environment containing inflammable or explosive gases.
- Never disassemble or modify the sensor.

DIMENSIONS (Unit: mm in)

The CAD data in the dimensions can be downloaded from our website.

FX-311□ FX-311□P Amplifier

CN-73-C1 CN-73-C2 CN-73-C5 Main cable (Optional)

Mounting drawing with a hand-turned knob attached cover FX-AJ1 (Optional)

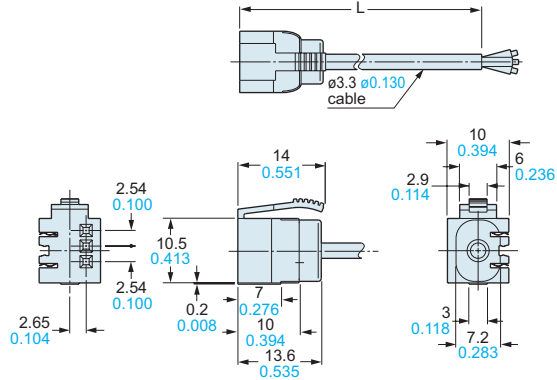
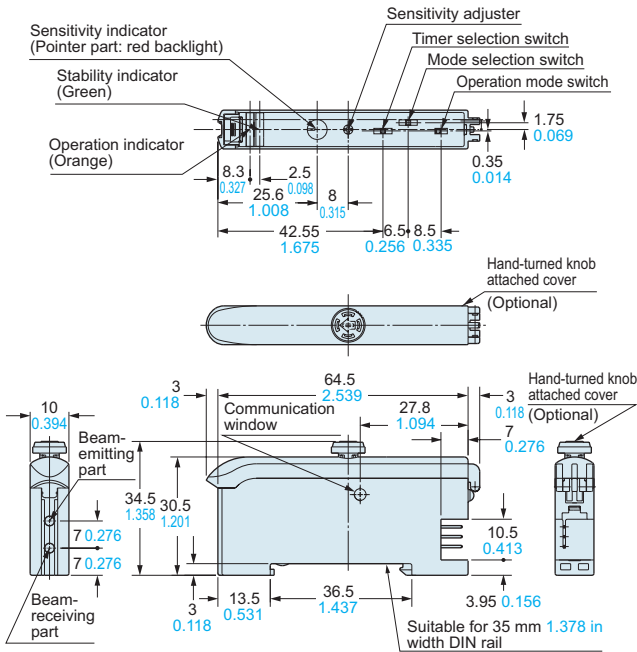

• Length L

Model No.	Length L
CN-73-C1	1,000 39.370
CN-73-C2	2,000 78.740
CN-73-C5	5,000 196.850

CN-71-C1 CN-71-C2 CN-71-C5 Sub cable (Optional)

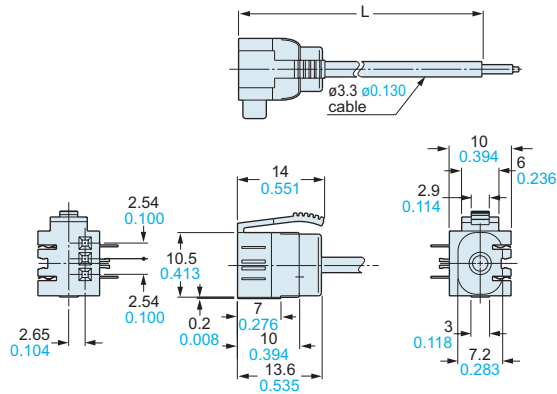

• Length L

Model No.	Length L
CN-71-C1	1,000 39.370
CN-71-C2	2,000 78.740
CN-71-C5	5,000 196.850

MS-DIN-2 Amplifier mounting bracket (Optional)

MS-DIN-E End plate (Optional)

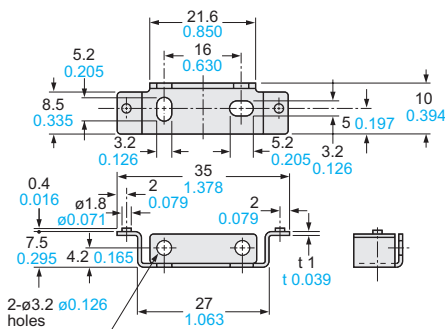

Material: Cold rolled carbon steel (SPCC)
(Uni-chrome plated)

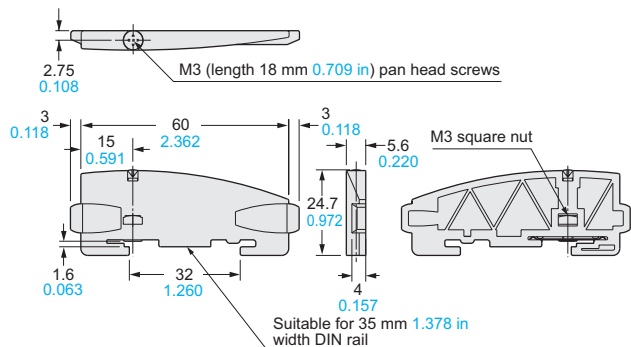

Material: Polycarbonate

FIBER SENSORS

LASER SENSORS

PHOTO-ELECTRIC SENSORS

MICRO PHOTO-ELECTRIC SENSORS

AREA SENSORS

LIGHT CURTAINS / SAFETY COMPONENTS

PRESSURE / FLOW SENSORS

INDUCTIVE PROXIMITY SENSORS

PARTICULAR USE SENSORS

SENSOR OPTIONS

SIMPLE WIRE-SAVING UNITS

WIRE-SAVING SYSTEMS

MEASUREMENT SENSORS

STATIC ELECTRICITY PREVENTION DEVICES

LASER MARKERS

PLC

HUMAN MACHINE INTERFACES

ENERGY CONSUMPTION VISUALIZATION COMPONENTS

FA COMPONENTS

MACHINE VISION SYSTEMS

UV CURING SYSTEMS

Selection Guide

Fibers

Fiber Amplifiers

FX-500

FX-100

FX-300

FX-410

FX-311

FX-301-F7/
FX-301-F