

FM-200 SERIES

Related Information

- General terms and conditions..... F-7
- Sensor selection guide P.731~
- Glossary of terms..... P.1469~
- General precautions P.1477~

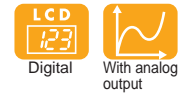

- FIBER SENSORS
- LASER SENSORS
- PHOTOELECTRIC SENSORS
- MICRO PHOTOELECTRIC SENSORS
- AREA SENSORS
- LIGHT CURTAINS / SAFETY COMPONENTS
- PRESSURE / FLOW SENSORS**
- INDUCTIVE PROXIMITY SENSORS
- PARTICULAR USE SENSORS
- SENSOR OPTIONS
- SIMPLE WIRE-SAVING UNITS
- WIRE-SAVING SYSTEMS
- MEASUREMENT SENSORS
- STATIC ELECTRICITY PREVENTION DEVICES
- LASER MARKERS
- PLC
- HUMAN MACHINE INTERFACES
- ENERGY CONSUMPTION VISUALIZATION COMPONENTS
- FA COMPONENTS
- MACHINE VISION SYSTEMS
- UV CURING SYSTEMS

Dual color with sub display at a glance

Easy-to-see dual color with sub display!

The setting conditions are displayed on the sub display, making it much easier to keep track of operations. In addition, the digital display which switches between 2 colors lets you check the status of sensor operation at a glance.

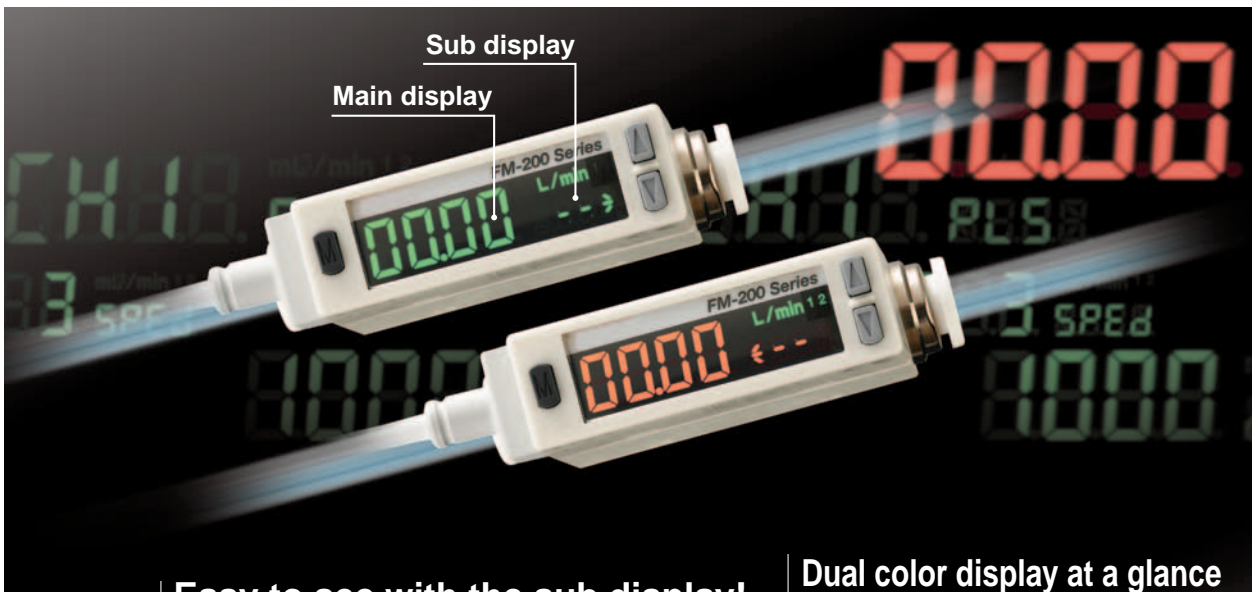

Easy to see with the sub display!

Setting values and setting items can be checked at the same time.



Dual color display at a glance

The display color changes in accordance with output ON / OFF operations.



Selection Guide
Pressure/ Digital Display
Pressure/ Head-separated
Flow

FM-200

APPLICATIONS

Controlling purge gas and air blowing

By controlling purge gas and air blowing, performance and quality of the products can be maintained, while contributing to cost reduction.

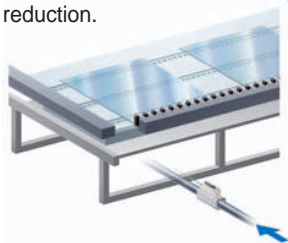

Checking seating

Flow sensors can be used for stable detection of transparent objects which were difficult to detect using photoelectric sensors. The nozzle can be extended for detection even in places where oil spatter occurs.

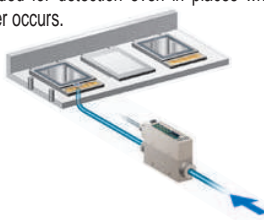

Checking suction

Detection of objects is possible even on conveyors with low suction pressures where air is flowing constantly (such as collet conveyors and network conveyors).

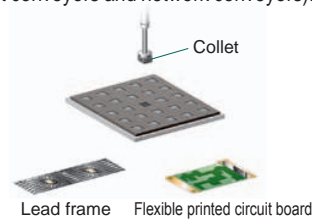

High precision of ±3 % F.S.

A new rectification mechanism and Micro Electro Mechanical System (MEMS) technology allow the sensor to be mounted on a Si sensor chip (3 × 3.5 mm 0.118 × 0.138 in). This provides an extremely small heat capacity, high precision of ±3 % F.S. and high-speed response. The two temperature sensors on each side of the heater detect the heat distribution to make bidirectional detection possible.

Principle of Si sensor chip

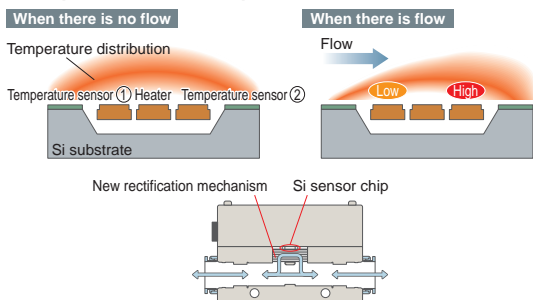

One sensor for both intake and exhaust

A single sensor can detect flows bidirectionally. In addition, it can be set to detect flows in either the forward or reverse direction only, making it suitable for a variety of applications.



For example, using a single sensor to check chip suction

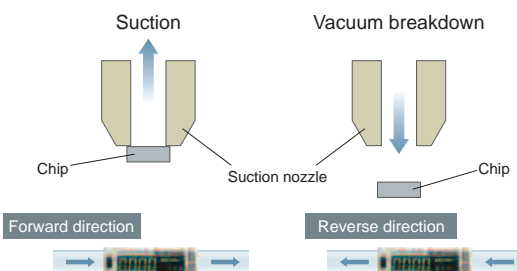

No straight pipes needed

The rectification method used by the new mechanism makes straight pipes unnecessary at both the intake and exhaust sides.



Connection

Quick connection is possible with a cover-attached connector.



Flexible installation direction

Other than the ability to carry out bidirectional detection, there are no limitations on the installation direction, making the installation very flexible.



Equipped with a wide variety of functions for greater ease of use

- **Integrated value reset function**
During integrated mode, external input allows reset of the integrated value.
- **Analog voltage output**
1 to 5 V analog voltage output is incorporated.
- **Key lock function**
Key operation can be disabled to prevent mis-operation.
- **Rattle prevention function (Response time setting)**
The response time can be set to one of seven steps from 50 ms to approximately 1,500 ms. This prevents rattling from rapid changes in flow or from noise.
- **Display rate setting**
The display update period for the digital display can be changed to 250 ms, 500 ms or 1,000 ms in order to eliminate display flickering.
- **ECO mode**
After approx. one minute of no operation, sensor will be switched to ECO mode. Backlight will be turned off to reduce power consumption.

FIBER SENSORS

LASER SENSORS

PHOTOELECTRIC SENSORS

MICRO PHOTOELECTRIC SENSORS

AREA SENSORS

LIGHT CURTAINS / SAFETY COMPONENTS

PRESSURE / FLOW SENSORS

INDUCTIVE PROXIMITY SENSORS

PARTICULAR USE SENSORS

SENSOR OPTIONS

SIMPLE WIRE-SAVING UNITS

WIRE-SAVING SYSTEMS

MEASUREMENT SENSORS

STATIC ELECTRICITY PREVENTION DEVICES

LASER MARKERS

PLC

HUMAN MACHINE INTERFACES

ENERGY CONSUMPTION VISUALIZATION COMPONENTS

FA COMPONENTS

MACHINE VISION SYSTEMS

UV CURING SYSTEMS

Selection Guide
Pressure/Digital Display
Pressure/Head-separated
Flow

FM-200

- FIBER SENSORS
- LASER SENSORS
- PHOTOELECTRIC SENSORS
- MICRO PHOTOELECTRIC SENSORS
- AREA SENSORS
- LIGHT CURTAINS / SAFETY COMPONENTS
- PRESSURE / FLOW SENSORS**
- INDUCTIVE PROXIMITY SENSORS
- PARTICULAR USE SENSORS
- SENSOR OPTIONS
- SIMPLE WIRE-SAVING UNITS
- WIRE-SAVING SYSTEMS
- MEASUREMENT SENSORS
- STATIC ELECTRICITY PREVENTION DEVICES
- LASER MARKERS
- PLC
- HUMAN MACHINE INTERFACES
- ENERGY CONSUMPTION VISUALIZATION COMPONENTS
- FA COMPONENTS
- MACHINE VISION SYSTEMS
- UV CURING SYSTEMS

- Selection Guide
- Pressure/Digital Display
- Pressure/Head-separated
- Flow

Suitable for cost and quality control! Integrated output mode incorporated

The **FM-200** series can control and manage flows in a wide variety of output modes such as integrated output mode, depending on the required application.

INTEGRATED FLOW RATE DISPLAY



Integrated flow rate can be displayed with 7 digits

Integrated output mode

Quality control

When the volume of flow of the gas being measured reaches the set integrated value, output switches to ON or OFF.

- Controls N₂ charging volumes for electronic components
- Controls air blowing volumes, etc.

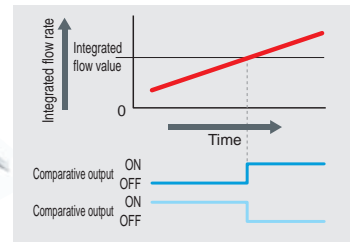
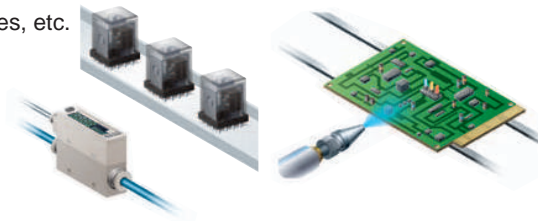

Integrated pulse output mode

Cost management

The pulse output is generated once at every specified integrated value*.

This lets you know the amount of air consumed per unit of time easily.

- Controls N₂ purge volumes in reflow furnaces
- Controls overall volumes of air consumed by equipment, etc.

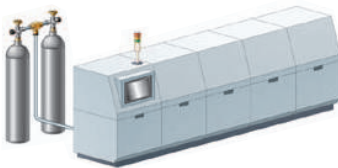

* Integrated values are specified by range and can vary. For details, refer to "SPECIFICATIONS" (p.795).

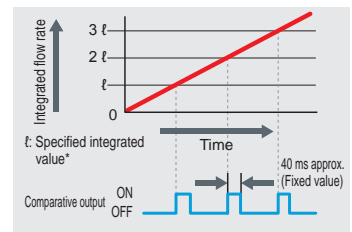

Energy-saving and environmental-friendly

The pulse output from the flow sensor can be inputted to the pulse counter of an Eco-Power Meter so that air consumption and power consumption can both be measured simultaneously.

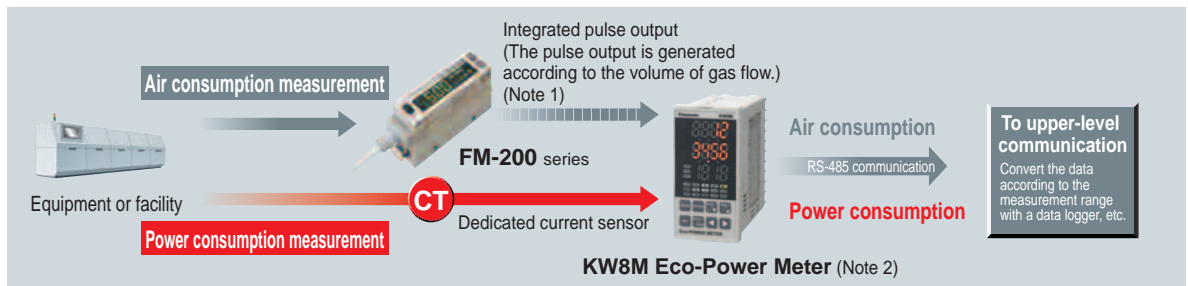

Notes: 1) Displayed value data is not outputted.
2) For details, please refer to our website Eco-Power Meter KW8M.

INSTANT FLOW RATE DISPLAY (FACTORY SETTING)



Window comparator mode

This mode is used for setting comparative output to ON or OFF at flow rates within the setting range.

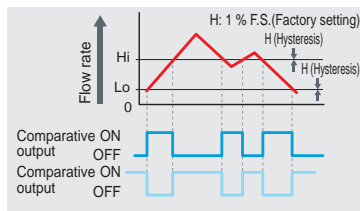

Hysteresis mode

This mode is used for setting comparative output hysteresis to the desired level and for carrying out ON / OFF control.

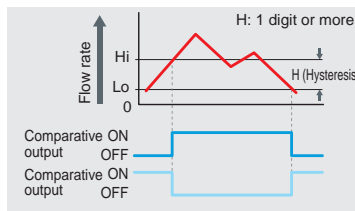

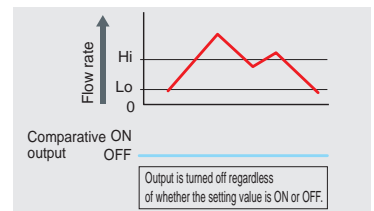

Output OFF mode

Comparative output is forcibly maintained at OFF regardless of the setting value.



ORDER GUIDE

Type	Appearance	Applicable fluid	Flow rate range	Model No.	Port size	Comparative output		
Resin body type		Clean air (Note) Compressed air (Note) Nitrogen gas	500 ml/min.	FM-252-4	ø4 ø0.157 push-in	NPN Open-collector transistor		
				FM-252-4-P		PNP Open-collector transistor		
			1,000 ml/min.	FM-213-4		NPN Open-collector transistor		
				FM-213-4-P		PNP Open-collector transistor		
			5 l/min.	FM-253-4		NPN Open-collector transistor		
				FM-253-4-P		PNP Open-collector transistor		
	10 l/min.		FM-214-4	NPN Open-collector transistor				
			FM-214-4-P	PNP Open-collector transistor				
	Aluminum body type			50 l/min.		FM-254-8	ø8 ø0.315 push-in	NPN Open-collector transistor
						FM-254-8-P		PNP Open-collector transistor
100 l/min.		FM-215-8		NPN Open-collector transistor				
		FM-215-8-P		PNP Open-collector transistor				
500 l/min.	Rc1/2 female thread	FM-255-AR2	NPN Open-collector transistor					
		FM-255-AR2-P	PNP Open-collector transistor					
	G1/2 female thread	FM-255-AG2-P	PNP Open-collector transistor					
		1,000 l/min.	FM-216-AR2	Rc1/2 female thread	NPN Open-collector transistor			
			FM-216-AR2-P	PNP Open-collector transistor				
G1/2 female thread	FM-216-AG2-P	G1/2 female thread	PNP Open-collector transistor					

Note: The clean air complies with JIS B 8392-1.1.1 to 5.6.2, and the compressed air complies with JIS B 8392-1.1.1 to 1.6.2.

Accessory

- **CN-F15-C1** (Connector attached cable 1 m 3.281 ft)



OPTIONS

Designation	Model No.	Description
Sensor mounting bracket	MS-FM2-1	Allows resin body type sensor to be installed on the flooring.
	MS-FM2-2	Allows aluminum body type sensor to be installed on the flooring.

Sensor mounting bracket

- **MS-FM2-1**

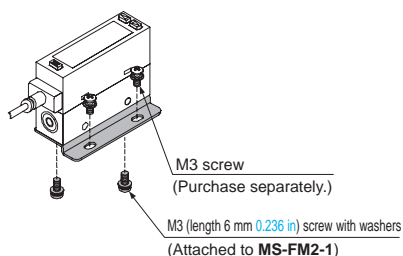

- **MS-FM2-2**

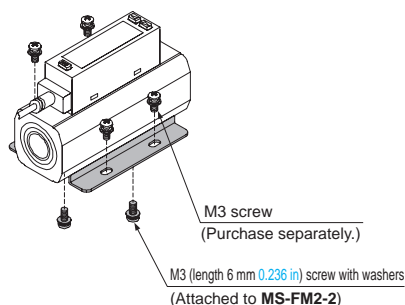

Recommended vacuum filter

Manufactured by Nihon Pisco Co., Ltd.
 VFU1-44-15P (Element length 15 mm 0.591 in)
 VFU1-44-25P (Element length 25 mm 0.984 in)
 VFE015B01 (Filter element for refill, length 15 mm 0.591 in)
 VFE025B01 (Filter element for refill, length 25 mm 0.984 in)



Note: Contact the manufacturer for details of the recommended products.

FIBER SENSORS

LASER SENSORS

PHOTO-ELECTRIC SENSORS

MICRO PHOTO-ELECTRIC SENSORS

AREA SENSORS

LIGHT CURTAINS / SAFETY COMPONENTS

PRESSURE / FLOW SENSORS

INDUCTIVE PROXIMITY SENSORS

PARTICULAR USE SENSORS

SENSOR OPTIONS

SIMPLE WIRE-SAVING UNITS

WIRE-SAVING SYSTEMS

MEASUREMENT SENSORS

STATIC ELECTRICITY PREVENTION DEVICES

LASER MARKERS

PLC

HUMAN MACHINE INTERFACES

ENERGY CONSUMPTION VISUALIZATION COMPONENTS

FA COMPONENTS

MACHINE VISION SYSTEMS

UV CURING SYSTEMS

Selection Guide

Pressure/Digital Display

Pressure/Head-separated

Flow

FM-200

SPECIFICATIONS**Individual specifications**

Type		Resin body type					
Item	Model No.	FM-252-4(-P)	FM-213-4(-P)	FM-253-4(-P)	FM-214-4(-P)	FM-254-8(-P)	FM-215-8(-P)
Instant flow rate	Full scale flow rate (Note 1)	500 ml/min.	1,000 ml/min.	5 l/min.	10 l/min.	50 l/min.	100 l/min.
	Display range (Note 2)	-550 to +550 ml/min.	-1,100 to +1,100 ml/min.	-5.5 to +5.5 l/min.	-11 to +11 l/min.	-55 to +55 l/min.	-110 to +110 l/min.
Integrated flow rate	Setting and display resolution	1 ml/min.		0.01 l/min.		0.1 l/min.	
	Display range (Note 2)	±9999999 ml		±99999.99 l		±999999.9 l	
	Setting and display resolution	1 ml		0.01 l		0.1 l	
	Specified integrated value	5 ml	10 ml	0.05 l	0.1 l	0.5 l	1 l
	Port size	ø4 ø0.157 push-in				ø8 ø0.315 push-in	
	Weight	Net weight: 50 g approx., Gross weight: 115 g approx.				Net weight: 70 g approx., Gross weight: 135 g approx.	

Type		Aluminum body type			
Item	Model No.	FM-255-AR2(-P)	FM-255-AG2-P	FM-216-AR2(-P)	FM-216-AG2-P
Instant flow rate	Full scale flow rate (Note 1)	500 l/min.		1,000 l/min.	
	Display range (Note 2)	-550 to +550 l/min.		-1,100 to +1,100 l/min.	
Integrated flow rate	Setting and display resolution	1 l/min.			
	Display range (Note 2)	±9999999 l			
	Setting and display resolution	1 l			
	Specified integrated value	5 l		10 l	
	Port size	Rc1/2 female thread	G1/2 female thread	Rc1/2 female thread	G1/2 female thread
	Weight	Net weight: 155 g approx., Gross weight: 220 g approx.			

Common specifications

Type		NPN output type		PNP output type	
Item	Model No.	FM-2□		FM-2□-P	
	Rated pressure range	-0.09 to +0.7 MPa			
	Pressure withstandability	1 MPa			
	Applicable fluid	Clean air (Note 3), compressed air (Note 3), nitrogen gas			
	Supply voltage	12 to 24 V DC ±10 % Ripple P-P10 % or less			
	Current consumption	Normal mode: 60 mA or less, ECO mode: 40 mA or less			
Comparative outputs (Comparative output 1 / Comparative output 2)		NPN open-collector transistor		PNP open-collector transistor	
		<ul style="list-style-type: none"> Maximum sink current: 50 mA or less Applied voltage: 26.4 V DC or less (between comparative output and 0 V) Residual voltage: 2.4 V or less (at 50 mA sink current) 		<ul style="list-style-type: none"> Maximum source current: 50 mA or less Applied voltage: 26.4 V DC or less (between comparative output and +V) Residual voltage: 2.4 V or less (at 50 mA source current) 	
	Output modes	Output OFF mode, window comparator mode, hysteresis mode, integrated output mode, integrated pulse output mode			
	Short-circuit protection	Incorporated			
	Hysteresis	Window comparator mode: 1 to 8 % F.S. approx. (variable) (Factory settings: approx. 1 % F.S.), Hysteresis mode: Variable (minimum 1 digit)			
	Response time	50 ms, 80 ms, 120 ms, 200 ms, 400 ms, 800 ms, 1,500 ms, selectable by key operation			
	Analog voltage output	Output voltage: 1 to 5 V, Output impedance: 1 kΩ approx.			
	Repeatability	Within ±1 % F.S.			
	Accuracy assurance range (Note 4)	Bi-direction : -100 to -3 % F.S., +3 to +100 % F.S. One-side direction : +3 to +100 % F.S.			
	External input	ON voltage: 0 to +0.4 V OFF voltage: +5 V to +V, or open Input time: 80 ms or more		ON voltage: +5 V to +V OFF voltage: 0 to +0.6 V, or open Input time: 80 ms or more	
	Linearity	Within ±3 % F.S. (Ambient temperature +25 °C +77 °F, flow rate range 3 to 100 % F.S., atmospheric criteria on secondary side)			
	Display	4 digits + 4 digits 2-color LCD display (Display refresh rate: 250 ms, 500 ms, 1,000 ms, selectable by key operation)			
Environmental resistance	Protection	IP40 (IEC)			
	Ambient temperature	0 to +50 °C +32 to +122 °F (No dew condensation allowed), Storage: -10 to +60 °C +14 to +140 °F			
	Ambient humidity	35 to 90 % RH, Storage: 35 to 90 % RH			
	Voltage withstandability	1,000 V AC for one min. between all supply terminals connected together and enclosure (Excluding the aluminum body type)			
	Insulation resistance	10 MΩ, or more, with 500 V DC megger between all supply terminals connected together and enclosure (Excluding the aluminum body type)			
	Vibration resistance / Shock resistance	10 to 150 Hz frequency, 0.75 mm 0.030 in amplitude or 49 ms ² max. acceleration, in X, Y and Z directions for two hours each / 100 ms ² acceleration (10 G approx.) in X, Y and Z directions for three times each			
	Temperature characteristics	Within ±0.2 % F.S./°C (+25 °C +77 °F criteria, +15 to +35 °C +59 to +95 °F ambient temperature range)			
	Pressure characteristics	Within ±5 % F.S. (-0.09 to +0.7 MPa, +25 °C +77 °F, atmospheric criteria on secondary side)			
	Enclosure earthing	Floating (Note 5)			
	Material	Enclosure: ABS, Body: Polyamide (Aluminum body type: Aluminum), Switch: EPDM, Display: Acrylic, Mounting screw part (Resin body type): Brass current plate / port filter: Stainless steel (used for the gas contact area), Sensor chip: Silicon, Gasket: Fluorine rubber			
	Connecting method	Connector			
	Cable length	Total length up to 10 m 32.808 ft is possible with 0.3 mm ² , or more, cable.			
	Accessory	CN-F15-C1 (Connector attached cable 1 m 3.281 ft): 1 pc.			

- Notes: 1) Converted to volumetric flow at +20 °C +68 °F and 1 atmospheric pressure (101 kPa).
2) The display flow rate range is the case when setting to bi-direction at the flow direction setting. When the flow direction is set to one-side forward direction or one-side reverse direction, the negative side of the display flow rate range shows 10 % of the full-scale (F.S.).
3) The clean air complies with JIS B 8392-1.1.1 to 5.6.2, and the compressed air complies with JIS B 8392-1.1.1 to 1.6.2.
4) Take care that if fluid flows in the vicinity of zero-point which is out of the accuracy assurance range, the instant flow rate value may forcibly display "zero", or the integrated flow display value may not be counted up, or the integrated pulse output may not be outputted.
5) As a varistor (clamping voltage: approx. 40 V) is connected to the aluminum body type, do not apply voltage higher than the rated voltage of the sensor.

I/O CIRCUIT AND WIRING DIAGRAMS

FM-2□

NPN output type

I/O circuit diagram

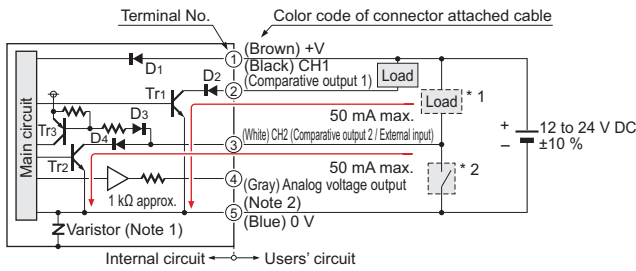

- Notes: 1) As for the aluminum body type, varistor (clamping voltage approx. 40 V) is connected between the internal power circuit and the metal body to prevent breakdown of the sensor. Connect the metal body to +V of power supply or to frame ground (F.G.) of a device that is connected to 0 V. High potential and insulation resistance tests between the internal power circuit and the metal body must not be done.
- 2) Short-circuit protection is not incorporated into the analog voltage output. Do not connect the power supply or capacitive load directly to the analog voltage output.

Symbols... D1 to D4 : Reverse supply polarity protection diode
Tr1, Tr2 : NPN output transistor
Tr3 : PNP input transistor

Wiring diagram

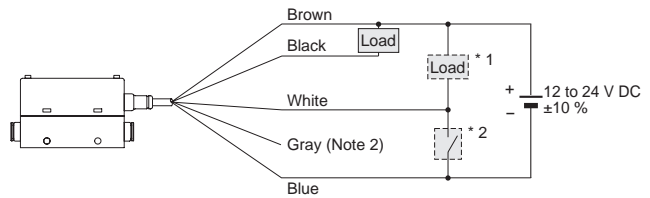

- * 1: When using CH2 as a comparative output 2
* 2: When using CH2 as an external input

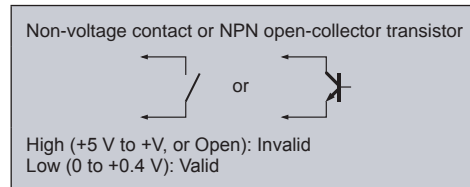

Analog voltage output

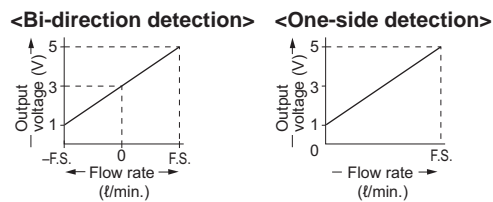

FM-2□-P

PNP output type

I/O circuit diagram

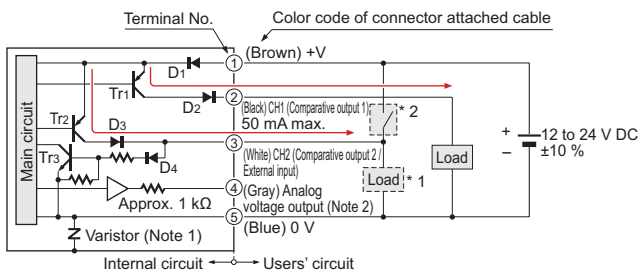

- Notes: 1) As for the aluminum body type, varistor (clamping voltage approx. 40 V) is connected between the internal power circuit and the metal body to prevent breakdown of the sensor. Connect the metal body to +V of power supply or to frame ground (F.G.) of a device that is connected to 0 V. High potential and insulation resistance tests between the internal power circuit and the metal body must not be done.
- 2) Short-circuit protection is not incorporated into the analog voltage output. Do not connect the power supply or capacitive load directly to the analog voltage output.

Symbols... D1 to D4 : Reverse supply polarity protection diode
Tr1, Tr2 : PNP output transistor
Tr3 : NPN input transistor

Wiring diagram

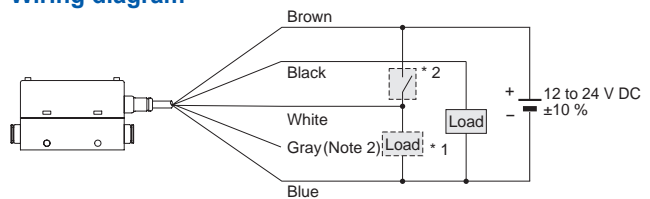

- * 1: When using CH2 as a comparative output 2
* 2: When using CH2 as an external input

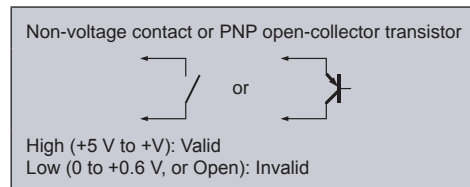

Analog voltage output

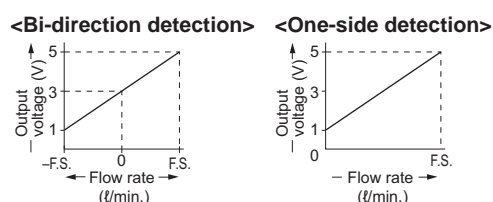

FIBER SENSORS

LASER SENSORS

PHOTO-ELECTRIC SENSORS

MICRO PHOTO-ELECTRIC SENSORS

AREA SENSORS

LIGHT CURTAINS / SAFETY COMPONENTS

PRESSURE / FLOW SENSORS

INDUCTIVE PROXIMITY SENSORS

PARTICULAR USE SENSORS

SENSOR OPTIONS

SIMPLE WIRE-SAVING UNITS

WIRE-SAVING SYSTEMS

MEASUREMENT SENSORS

STATIC ELECTRICITY PREVENTION DEVICES

LASER MARKERS

PLC

HUMAN MACHINE INTERFACES

ENERGY CONSUMPTION VISUALIZATION COMPONENTS

FA COMPONENTS

MACHINE VISION SYSTEMS

UV CURING SYSTEMS

Selection Guide

Pressure/ Digital Display

Pressure/ Head separated

Flow

FM-200

PRESSURE LOSS CHARACTERISTICS (TYPICAL)

- FIBER SENSORS
- LASER SENSORS
- PHOTO-ELECTRIC SENSORS
- MICRO PHOTO-ELECTRIC SENSORS
- AREA SENSORS
- LIGHT CURTAINS / SAFETY COMPONENTS
- PRESSURE / FLOW SENSORS**
- INDUCTIVE PROXIMITY SENSORS
- PARTICULAR USE SENSORS
- SENSOR OPTIONS
- SIMPLE WIRE-SAVING UNITS
- WIRE-SAVING SYSTEMS
- MEASUREMENT SENSORS
- STATIC ELECTRICITY PREVENTION DEVICES
- LASER MARKERS
- PLC
- HUMAN MACHINE INTERFACES
- ENERGY CONSUMPTION VISUALIZATION COMPONENTS
- FA COMPONENTS
- MACHINE VISION SYSTEMS
- UV CURING SYSTEMS
- Selection Guide
- Pressure / Digital Display
- Pressure / Head-separated
- Flow

FM-252-4(-P)

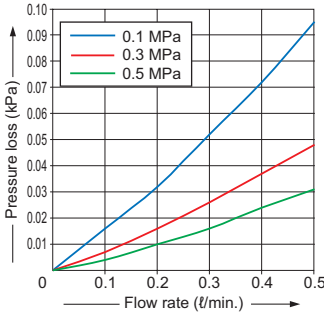

FM-213-4(-P)

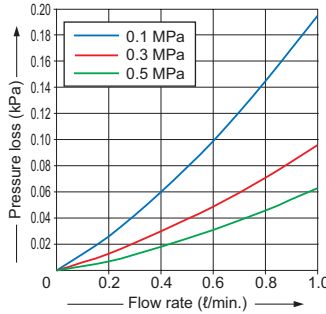

FM-253-4(-P)

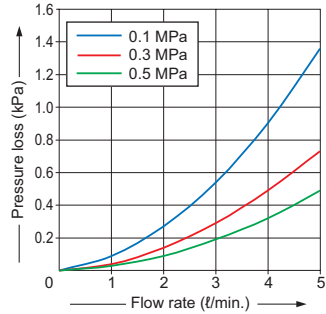

FM-214-4(-P)

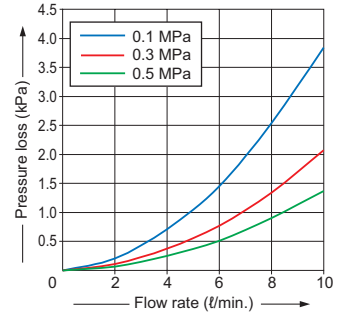

FM-254-8(-P)

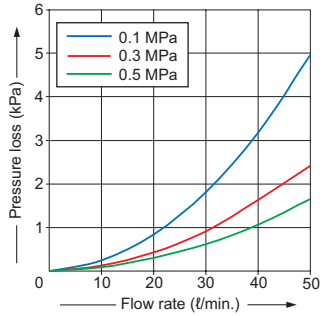

FM-215-8(-P)

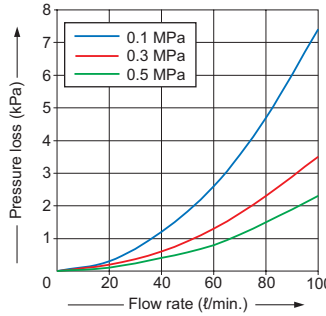

FM-255-A□2(-P)

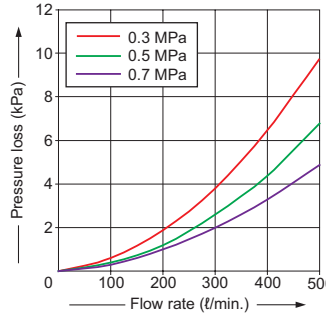

FM-216-A□2(-P)

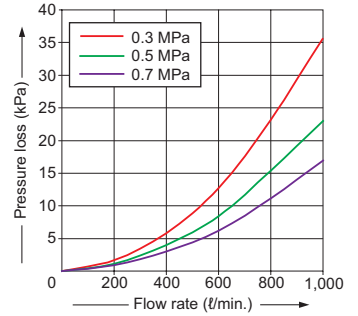

PRECAUTIONS FOR PROPER USE

Refer to p.1477~ for general precautions.



- Never use this product as a sensing device for personnel protection.
- In case of using sensing devices for personnel protection, use products which meet laws and standards, such as OSHA, ANSI or IEC etc., for personnel protection applicable in each region or country.
- This product is for use in air and nitrogen only. Do not use the product for other fluids since the sensing accuracy cannot be guaranteed.
- Take care that if foreign materials are mixed in the sensing part, the product may break.

Terminal arrangement diagram

Terminal arrangement of the connectors of this product (sensor body)

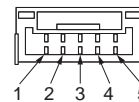

Connector pin No.	Color code of the connector attached cable	Terminal
1	Brown	+V
2	Black	CH1 (comparative output 1)
3	White	CH2 (comparative output 2 / external input)
4	Gray	Analog voltage output
5	Blue	0 V

Part description

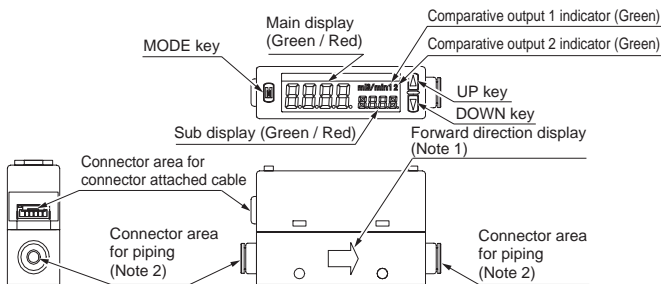

- Notes: 1) Direction of the arrow indicates the forward direction of flow rate when setting the flow direction to bi-direction or one-side forward direction. When setting the flow direction to one-side reverse direction, a direction opposite to the forward direction display will be the forward direction of the flow rate.
- 2) $\varnothing 4$ mm $\varnothing 0.157$ in push-in joint / $\varnothing 8$ mm $\varnothing 0.315$ in push-in joint is incorporated in **FM-2□-4 (-P)** / **FM-2□-8 (-P)**, respectively. The push-in joint is not incorporated in the aluminum body type.

PRECAUTIONS FOR PROPER USE

Refer to p.1477~ for general precautions.

Mounting

- This product can be installed facing up or down or to the left or right.

Horizontal mounting

- Use M3 screws, and the tightening torque should be 0.5 N·m.

<Resin body type>

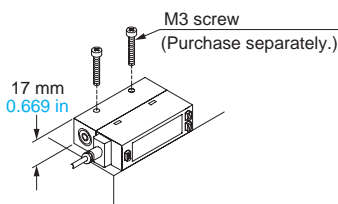

Vertical mounting

- Use M3 screws, and the tightening torque should be 0.5 N·m.

<Resin body type>

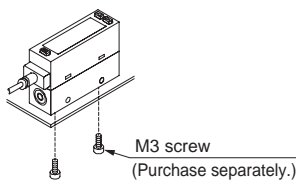

<Aluminum body type>

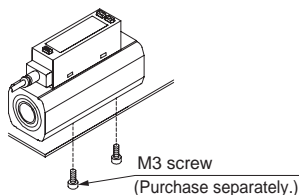

When using sensor mounting bracket

- When mounting the product on the sensor mounting bracket **MS-FM2-1** (optional) or **MS-FM2-2** (optional), use the M3 screws (length 6 mm 0.236 in) attached to the sensor mounting bracket. The tightening torque should be 0.5 N·m. Use M3 screws to mount the sensor mounting bracket on a sensing surface.

<Resin body type>

Use **MS-FM2-1**

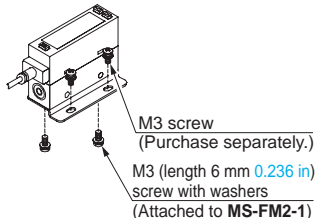

<Aluminum body type>

Use **MS-FM2-2**

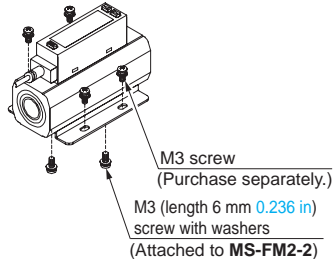

Piping

- The following specified tube should be used to insert to the push-in joint type product.

Material of tube	Tube diameter (mm in)	Allowable diameter
Polyamide	ø4 ø0.157, ø8 ø0.315	Within ±0.1 mm ±0.004 in
Polyurethane	ø4 ø0.157	Within ±0.1 mm ±0.004 in
	ø8 ø0.315	Within +0.1 / -0.15 mm ±0.004 in / -0.006 in

- Before using this product, make sure to check that the tube is firmly inserted.

- Install a filter, an air dryer and an oil mist filter (micro-alescer) onto the primary side (upstream) of this product since the compressed air from the compressor contains drain (water, oil oxide and foreign materials, etc.). Mesh (wire net) in this product is used to rectify the flow rate in the pipe. Always install a filter to the primary side of this product since this mesh is not a filter to remove foreign materials.

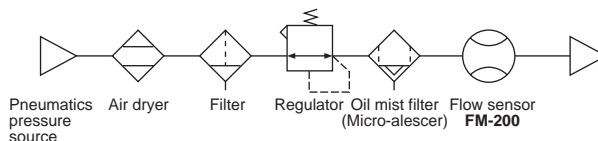

- When using a valve on the primary side of the product, only use an oil-prohibit specification valve. This product may malfunction or break if subject to splattering grease or oil, etc.
- When using this product for suction verification, etc., always install an air filter whose filtration property is 10 µm 0.394 mil or less onto the suction side to prevent suction of foreign materials and water. Furthermore, consider atmospheric dew point and ambient temperature of the product, use the product under the conditions that dew condensations will not be formed in the inside of pipe.
- In case of mounting commercial joint to the aluminum body type, apply a spanner on the metal part of this product and tighten by the tightening torque of 16 to 18 N·m. If excessive torque is applied, the commercial joint or the main body may break.
- When piping, take care that foreign materials such as sealing tape and adhesive must not enter into the inside of the pipe. If foreign materials are entered, the product may malfunction or break.
- Make sure to mount the joint when using the product with its secondary side (downstream) open to the air. If the joint is not mounted, the port filter of the product may fall off.

Wiring

- Make sure that the power supply is OFF during wiring.
- Take care that wrong wiring will damage this product.
- Take care if applying voltage exceeding the rated range, or connecting to AC power supply, this product may break or burn.
- If power is supplied from a commercial switching regulator, ensure that the frame ground (F.G.) terminal of the power supply is connected to an actual ground.
- In case noise generating equipment (switching regulator, inverter motor, etc.) is used in the vicinity of this sensor, connect the frame ground (F.G.) terminal of the equipment to an actual ground.
- Do not run the wires together with high-voltage lines or power lines or put them in the same raceway. This can cause malfunction due to induction.
- Extension up to total 10 m 32.808 ft is possible with 0.3 mm², or more, cable.
- Make sure that stress by forcible bend or pulling is not applied directly to the sensor cable joint.

FIBER SENSORS

LASER SENSORS

PHOTO-ELECTRIC SENSORS

MICRO PHOTO-ELECTRIC SENSORS

AREA SENSORS

LIGHT CURTAINS / SAFETY COMPONENTS

PRESSURE / FLOW SENSORS

INDUCTIVE PROXIMITY SENSORS

PARTICULAR USE SENSORS

SENSOR OPTIONS

SIMPLE WIRE-SAVING UNITS

WIRE SAVING SYSTEMS

MEASUREMENT SENSORS

STATIC ELECTRICITY PREVENTION DEVICES

LASER MARKERS

PLC

HUMAN MACHINE INTERFACES

ENERGY CONSUMPTION VISUALIZATION COMPONENTS

FA COMPONENTS

MACHINE VISION SYSTEMS

UV CURING SYSTEMS

Selection Guide

Pressure / Digital Display

Pressure / Head-separated

Flow

FM-200

PRECAUTIONS FOR PROPER USE

Refer to p.1477~ for general precautions.

Others

- Take care if foreign materials are mixed in the sensing part, the product may break.
- Do not use this product for commercial purposes since the product does not comply with International System of Units (SI).
- Do not apply pressure that exceed resistant-pressure.
- Do not use during the initial transient time (approx. 5 sec.) after the power supply is switched ON.
- The specifications may not be satisfied in a strong magnetic field.
- Accuracy of the display and the analog voltage output is influenced by self-heating by applying current other than the temperature characteristics. Standby time (5 min. or more after applying current) should be taken when using the product.
- These sensors are only for indoor use.
- Do not use this product in places having excessive vapor, dust, etc., or where it may come in contact with corrosive gas, etc.
- Take care that the product does not come in contact with water, oil, grease, or organic solvents such as thinner, etc., strong acid or alkaline.
- Do not drop the product or apply hard shock. This can cause product breakage.

FLOW SENSOR SELECTION

• If using a flow sensor for tasks such as checking suction and release from suction nozzles and sensing leaks, use the flow rate range setting table as a guide. The effective cross-section area of the nozzle (pinhole) and the difference in pressure inside and outside the nozzle can be used to calculate the flow rate.

- For $P_1 \geq 1.89 \times P_2$ (acoustic velocity)
 $Q = 113.2 \times S \times P_1$
 - For $P_1 < 1.89 \times P_2$ (sub-acoustic velocity)
 $Q = 226.4 \times S \times \sqrt{P_2(P_1 - P_2)}$
- Q : Flow rate ℓ/min.
 P₁ : Absolute pressure at primary side (MPa)
 P₂ : Absolute pressure at secondary side (MPa)
 S≥: Effective cross-section area of nozzle (pinhole) mm²

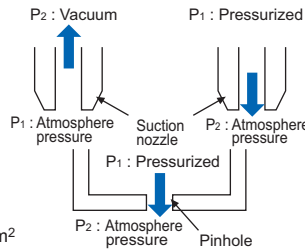

<Calculation example>

The flow rate calculation value for a nozzle diameter of ø0.1 to ø2.0 mm ø0.004 to ø0.079 in when P₂ is varied is shown in the table below.

	P ₁ (MPa) Absolute pressure	P ₁ (MPa) Gauge pressure	P ₂ (MPa) Absolute pressure	P ₂ (MPa) Gauge pressure	Acoustic velocity / Sub-acoustic velocity	Calculated flow rate value (ℓ / min)									
						ø0.1 mm ø0.004 in	ø0.2 mm ø0.008 in	ø0.3 mm ø0.012 in	ø0.4mm ø0.016 in	ø0.5mm ø0.020 in	ø0.7 mm ø0.027 in	ø1.0 mm ø0.039 in	ø1.5 mm ø0.059 in	ø2.0 mm ø0.079 in	
Suction	0.1013	0	0.0313	-0.07	Acoustic velocity	0.090	0.360	0.810	1.440	2.250	4.411	9.002	20.254	36.007	
	0.1013	0	0.0413	-0.06	Acoustic velocity	0.090	0.360	0.810	1.440	2.250	4.411	9.002	20.254	36.007	
	0.1013	0	0.0513	-0.05	Acoustic velocity	0.090	0.360	0.810	1.440	2.250	4.411	9.002	20.254	36.007	
	0.1013	0	0.0613	-0.04	Sub-acoustic velocity	0.088	0.352	0.792	1.408	2.200	4.312	8.800	19.801	35.202	
	0.1013	0	0.0713	-0.03	Sub-acoustic velocity	0.082	0.329	0.740	1.315	2.055	4.028	8.220	18.494	32.878	
	0.1013	0	0.0813	-0.02	Sub-acoustic velocity	0.072	0.287	0.645	1.147	1.792	3.512	7.166	16.125	28.666	
Blow (leakage detection)	0.1013	0	0.0913	-0.01	Sub-acoustic velocity	0.054	0.215	0.483	0.859	1.343	2.631	5.370	12.083	21.480	
	0.1113	0.01	0.1013	0	Sub-acoustic velocity	0.057	0.226	0.509	0.905	1.414	2.772	5.657	12.727	22.626	
	0.1213	0.02	0.1013	0	Sub-acoustic velocity	0.080	0.320	0.720	1.280	2.000	3.920	8.000	17.999	31.998	
	0.1413	0.04	0.1013	0	Sub-acoustic velocity	0.113	0.453	1.018	1.810	2.828	5.543	11.313	25.454	45.252	
	0.1613	0.06	0.1013	0	Sub-acoustic velocity	0.139	0.554	1.247	2.217	3.464	6.789	13.856	31.175	55.423	
	0.1813	0.08	0.1013	0	Sub-acoustic velocity	0.160	0.640	1.440	2.560	4.000	7.840	15.999	35.998	63.996	
	0.2013	0.1	0.1013	0	Acoustic velocity	0.179	0.716	1.610	2.862	4.472	8.765	17.888	40.248	71.552	
	0.3013	0.2	0.1013	0	Acoustic velocity	0.268	1.071	2.410	4.284	6.694	13.119	26.774	60.242	107.096	
	0.4013	0.3	0.1013	0	Acoustic velocity	0.357	1.426	3.209	5.706	8.915	17.474	35.660	80.236	142.641	
	0.5013	0.4	0.1013	0	Acoustic velocity	0.445	1.782	4.009	7.127	11.137	21.828	44.547	100.230	178.186	
0.6013	0.5	0.1013	0	Acoustic velocity	0.534	2.137	4.809	8.549	13.358	26.182	53.433	120.224	213.731		

- Notes: 1) In case of any leakage from tubes, etc., actual values will differ greatly from calculated values. When measuring flows, make sure that there is no leakage from any tubes.
 2) In case of any points in the tubes which are narrower than the diameter of the suction nozzle, flow rate will be restricted and may turn out to be lower than the calculated values.
 In addition, suction verification may not be possible in such cases.
 3) The effective cross-section area is a guide only. If the nozzle is long and narrow, the effective cross-section area may be smaller than the area at the tip of the nozzle.
 4) Response times are determined by the internal volume of the tube from the flow sensor to the suction nozzle (pinhole). If carrying out high-speed sensing, reduce the internal volume of the tube as much as possible such as by locating the flow sensor as close as possible to the suction nozzle.

DIMENSIONS (Unit:mm in)

The CAD data in the dimensions can be downloaded from our website.

FM-2□-4(-P) Sensor

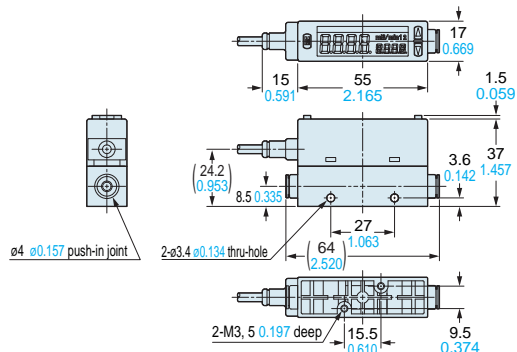

FM-2□-8(-P) Sensor

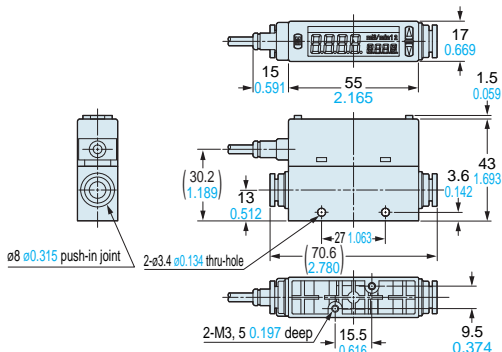

FM-2□-A□(-P) Sensor

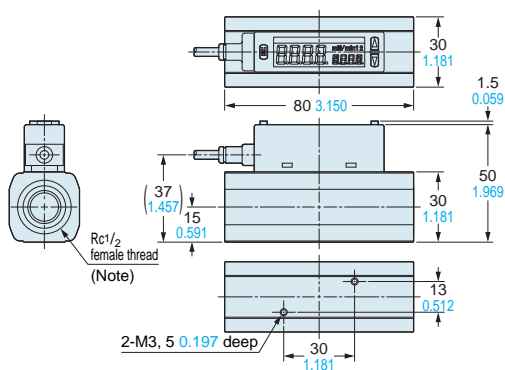

CN-F15-C1 Connector attached cable (Accessory)

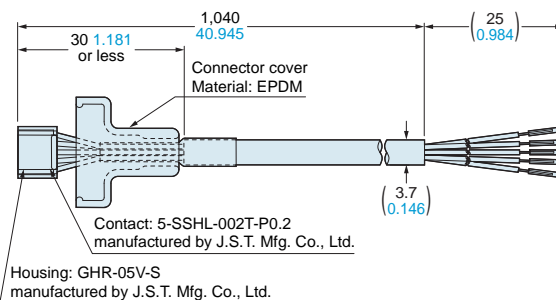

Note: FM-2□-AG2-P has G1/2 female thread.

MS-FM2-1 Sensor mounting bracket (Optional)

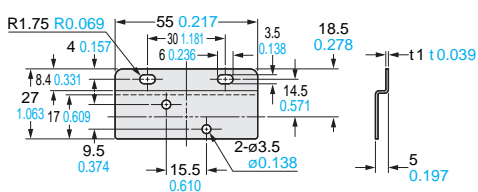

MS-FM2-2 Sensor mounting bracket (Optional)

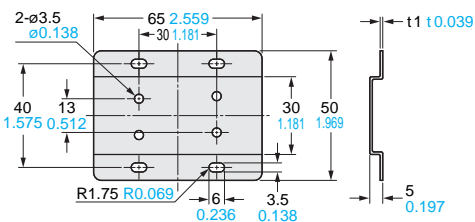

Material: Cold rolled carbon steel (SPCC)(Nickel plated)
Two M3 (length 6 mm 0.236 in) screws with washers are attached.

Material: Cold rolled carbon steel (SPCC)(Nickel plated)
Two M3 (length 6 mm 0.236 in) screws with washers are attached.

Assembly dimensions

Mounting drawing with **FM-252-4**

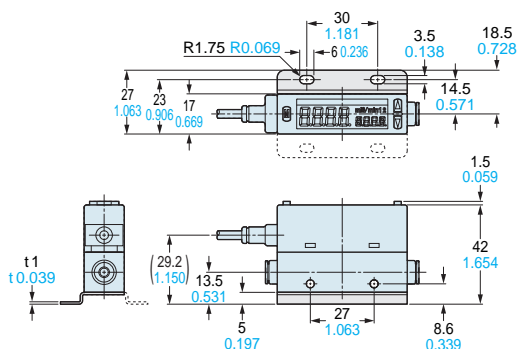

Assembly dimensions

Mounting drawing with **FM-255-AR2**

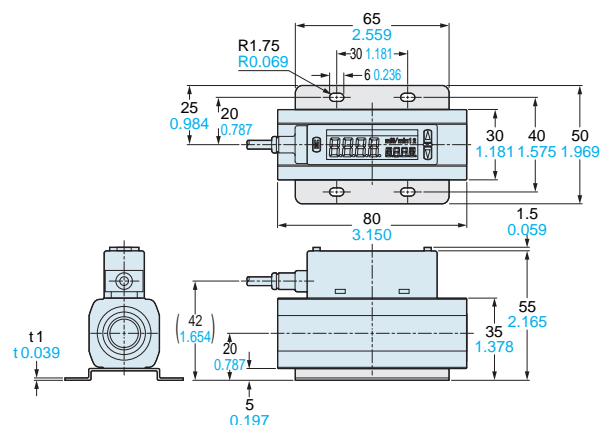

FIBER SENSORS

LASER SENSORS

PHOTO-ELECTRIC SENSORS

MICRO PHOTO-ELECTRIC SENSORS

AREA SENSORS

LIGHT CURTAINS / SAFETY COMPONENTS

PRESSURE / FLOW SENSORS

INDUCTIVE PROXIMITY SENSORS

PARTICULAR USE SENSORS

SENSOR OPTIONS

SIMPLE WIRE-SAVING UNITS

WIRE-SAVING SYSTEMS

MEASUREMENT SENSORS

STATIC ELECTRICITY PREVENTION DEVICES

LASER MARKERS

PLC

HUMAN MACHINE INTERFACES

ENERGY CONSUMPTION VISUALIZATION COMPONENTS

FA COMPONENTS

MACHINE VISION SYSTEMS

UV CURING SYSTEMS

Selection Guide

Pressure/ Digital Display

Pressure/ Head-separated

Flow

Flow

Flow

Flow

Flow

Flow

Flow

Flow

Flow

Flow

Flow

Flow

Flow

Flow

Flow

Flow

Flow