

Water Detection Sensor EZ-10 SERIES

Related Information

- General terms and conditions.....F-3
- Selection guide P.865~
- Glossary of terms.....P.1549~
- General precautions.....P.1552~

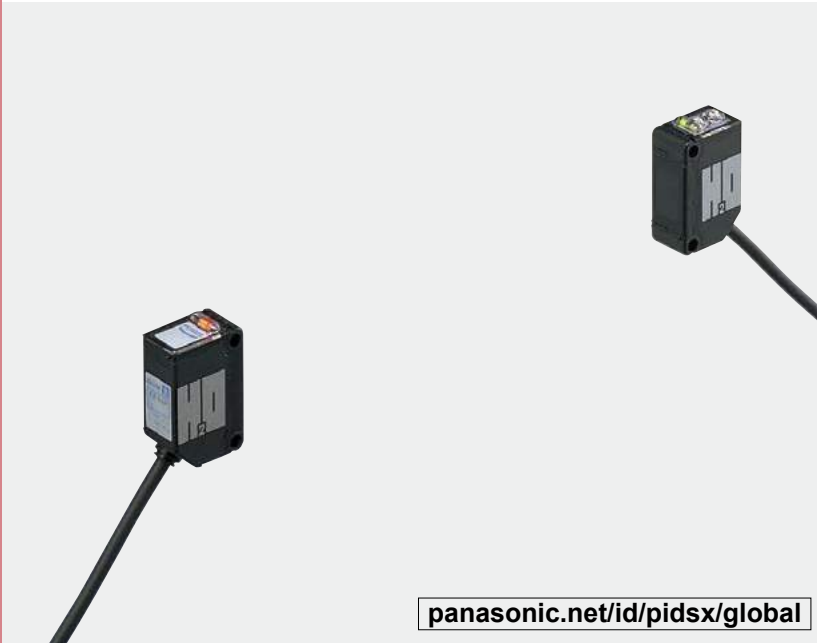

panasonic.net/id/pidsx/global

Detects water...reliably!

Strong penetration power

As the penetration power is strong, its beam can pass through not only translucent containers (PFA tanks, etc.) but also opaque containers of shampoo bottles, etc., and can reliably detect the liquid inside.

Penetration in case of an empty container (Typical)

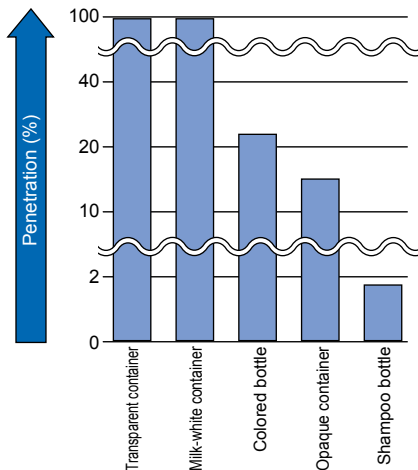

* The graph above is merely a guideline. Penetration power changes due to container material, thickness and color. We strongly recommend that you conduct verification tests prior to use.

Not affected by drops, bubbles or froth

It is possible to set its sensitivity adjuster so that water drops, bubbles in the water, or froth on the water surface are not detected.

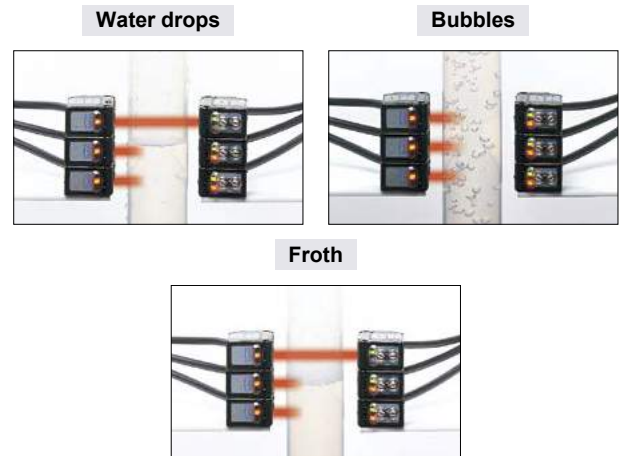

IP67 protection

The sensor can be hosed down because of its IP67 construction and the non-corrosive stainless steel sensor mounting bracket.

Note: However, take care that if it is exposed to water splashes during operation, it will detect the splashed water itself.

Adjacent sensor mounting possible

Several sensors can be mounted adjacently by fitting optional slit masks. Further, they can detect the liquid level accurately.

Plug-in connector type is available

Plug-in connector type which enables connection / disconnection of the cable by one-touch is available. Anyone can easily replace the sensor in a minute.

- FIBER SENSORS
- LASER SENSORS
- PHOTOELECTRIC SENSORS
- MICRO PHOTOELECTRIC SENSORS
- AREA SENSORS
- SAFETY LIGHT CURTAINS / SAFETY COMPONENTS
- PRESSURE / FLOW SENSORS
- INDUCTIVE PROXIMITY SENSORS
- PARTICULAR USE SENSORS**
- SENSOR OPTIONS
- SIMPLE WIRE- SAVING UNITS
- WIRE- SAVING SYSTEMS
- MEASUREMENT SENSORS
- STATIC CONTROL DEVICES
- LASER MARKERS
- PLC
- HUMAN MACHINE INTERFACES
- ENERGY MANAGEMENT SOLUTIONS
- FA COMPONENTS
- MACHINE VISION SYSTEMS
- UV CURING SYSTEMS
- Selection Guide
- Liquid Leak Detection
- Liquid Level Detection
- Water Detection
- Color Mark Detection
- Wafer Detection
- Ultrasonic
- Small / Slim Object Detection
- Obstacle Detection

APPLICATIONS

Detecting level of aqueous solution in resin tank
It can reliably detect a liquid even in an opaque container.

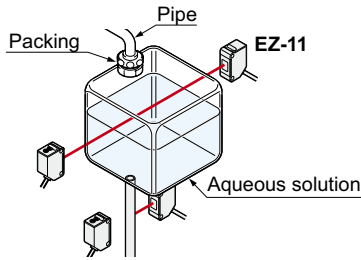

Detecting the boundary between water and oil
Since it does not detect oil, it can reliably detect the boundary between water and oil.

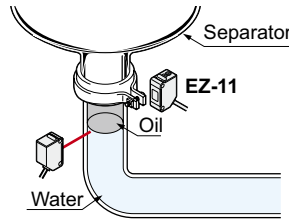

Detecting presence of liquid in colored bottle
Aqueous liquids in translucent colored bottles can be reliably detected.

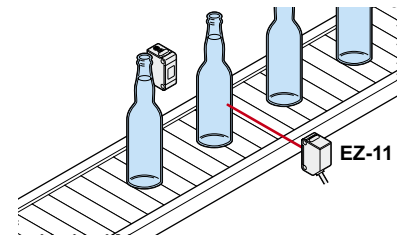

ORDER GUIDE

Type	Appearance	Sensing range (Note 1)	Model No. (Note 2)	Output
NPN output		5m 16.404 ft (without container or pipe)	EZ-11	NPN open-collector transistor
PNP output			EZ-11-PN	PNP open-collector transistor

NOTE: Mounting bracket is not supplied with the sensor. Please select from the range of optional sensor mounting brackets (five types).

Notes: 1) The sensing range shortens depending on the thickness, material, color, etc., of the container or pipe.
2) Models whose model name on the product nameplate is followed by "P" are emitters, while those whose model name is followed by "D" are receivers.

5 m 16.404 ft cable length type and plug-in connector type

5 m 16.404 ft cable length type (standard: 2 m 6.562 ft) and plug-in connector type (standard: cable type) are also available. (5 m 16.404 ft cable length type is not available for the **EZ-11-PN**.)
When ordering this type, suffix "-C5" for 5 m 16.404 ft cable length type, "-J" for plug-in connector type to the model No. Please order the suitable mating cable separately for plug-in connector type.
(e.g.) Plug-in connector type of **EZ-11-PN** is "**EZ-11-PN-J**".

• Mating cable for plug-in connector type (2 cables are required)

Type	Model No.	Description
Straight	CN-24E-C2	Length: 2 m 6.562 ft
	CN-24E-C5	Length: 5 m 16.404 ft
Elbow	CN-24EL-C2	Length: 2 m 6.562 ft
	CN-24EL-C5	Length: 5 m 16.404 ft

0.2 mm² 4-core cabtyre cable with connector on one end
Cable outer diameter: ø3.7 mm ø0.146 in

• CN-24E-C2, CN-24E-C5

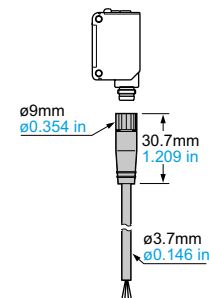

• CN-24EL-C2, CN-24EL-C5

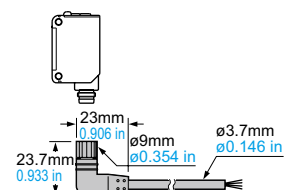

FIBER SENSORS

LASER SENSORS

PHOTO-ELECTRIC SENSORS

MICRO PHOTO-ELECTRIC SENSORS

AREA SENSORS

SAFETY LIGHT CURTAINS / SAFETY COMPONENTS

PRESSURE / FLOW SENSORS

INDUCTIVE PROXIMITY SENSORS

PARTICULAR USE SENSORS

SENSOR OPTIONS

SIMPLE WIRE-SAVING UNITS

WIRE-SAVING SYSTEMS

MEASUREMENT SENSORS

STATIC CONTROL DEVICES

LASER MARKERS

PLC

HUMAN MACHINE INTERFACES

ENERGY MANAGEMENT SOLUTIONS

FA COMPONENTS

MACHINE VISION SYSTEMS

UV CURING SYSTEMS

UV CURING SYSTEMS

Selection Guide

Liquid Leak Detection

Liquid Level Detection

Water Detection

Color Mark Detection

Wafer Detection

Ultrasonic

Small / Slim Object Detection

Obstacle Detection

EZ-10

OPTIONS

Designation	Model No.	Description
Round slit mask	OS-CX-05 (Slit size $\varnothing 0.5$ mm) $\varnothing 0.020$ in	Slit on one side • Sensing range: 200 mm 7.874 in
		Slit on both sides • Sensing range: 10 mm 0.394 in
	OS-CX-1 (Slit size $\varnothing 1$ mm) $\varnothing 0.039$ in	Slit on one side • Sensing range: 400 mm 15.748 in
		Slit on both sides • Sensing range: 60 mm 2.362 in
	OS-CX-2 (Slit size $\varnothing 2$ mm) $\varnothing 0.079$ in	Slit on one side • Sensing range: 1 m 3.281 ft
		Slit on both sides • Sensing range: 250 mm 9.843 in
Rectangular slit mask	OS-CX-05×6 (Slit size 0.5×6 mm) 0.020×0.236 in	Slit on one side • Sensing range: 800 mm 31.496 in
		Slit on both sides • Sensing range: 250 mm 9.843 in
	OS-CX-1×6 (Slit size 1×6 mm) 0.039×0.236 in	Slit on one side • Sensing range: 1.3 m 4.265 ft
		Slit on both sides • Sensing range: 600 mm 23.622 in
	OS-CX-2×6 (Slit size 2×6 mm) 0.079×0.236 in	Slit on one side • Sensing range: 2 m 6.562 ft
		Slit on both sides • Sensing range: 1.3 m 4.265 ft
Sensor mounting bracket (Note 1)	MS-CX2-1	Foot angled mounting bracket (Two brackets are required.)
	MS-CX2-2	Foot biangled mounting bracket (Two brackets are required.)
	MS-CX2-4	Protective mounting bracket (Two brackets are required.)
	MS-CX2-5	Back biangled mounting bracket (Two brackets are required.)
	MS-CX-3	Back angled mounting bracket (Two brackets are required.)
Universal sensor mounting stand (Note 2)	MS-AJ1	Horizontal mounting type
	MS-AJ2	Vertical mounting type
	MS-AJ1-A	Horizontal mounting type
	MS-AJ2-A	Vertical mounting type

Notes: 1) The plug-in connector type sensor does not allow use of some sensor mounting brackets because of the protrusion of the connector.
2) Refer to p.953~ for the universal sensor mounting stand.

Universal sensor mounting stand

• **MS-AJ1**

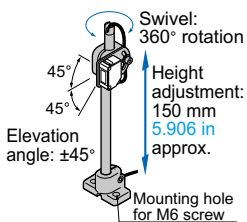

• **MS-AJ1-A**

With the lateral arm, the sensor can sense from above a production line.

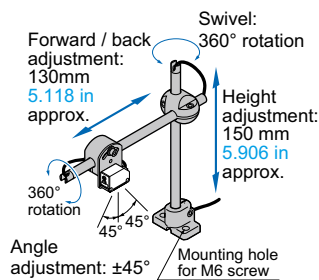

• **MS-AJ2**

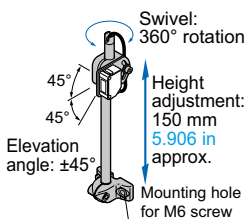

• **MS-AJ2-A**

With the lateral arm, the sensor can sense from above a production line.

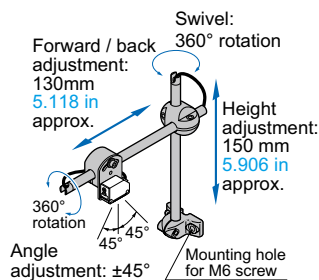

Round slit mask

• **OS-CX-□**

Used for narrowing the beam for cases when detecting water or other substances inside slender pipes. Fitted on the front face of the sensor with one-touch.

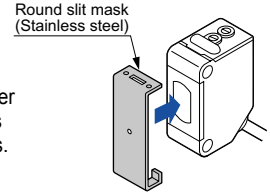

Rectangular slit mask

• **OS-CX-□×6**

Used for narrowing the beam for cases when detecting water or other substances inside slender pipes. Fitted on the front face of the sensor with one-touch.

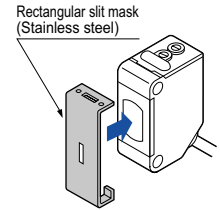

Sensor mounting bracket

• **MS-CX2-1**

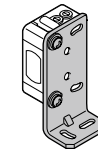

Two M3 (length 12 mm **0.472 in**) screws with washers are attached.

• **MS-CX2-2**

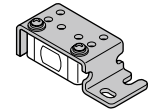

Two M3 (length 12 mm **0.472 in**) screws with washers are attached.

• **MS-CX2-4**

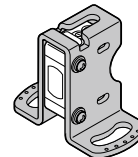

Two M3 (length 14 mm **0.551 in**) screws with washers are attached.

• **MS-CX2-5**

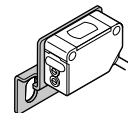

Two M3 (length 12 mm **0.472 in**) screws with washers are attached.

• **MS-CX-3**

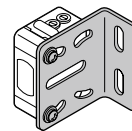

Two M3 (length 12 mm **0.472 in**) screws with washers are attached.

SPECIFICATIONS

Item	Type	NPN output	PNP output
	Model No.	EZ-11	EZ-11-PN
CE marking directive compliance	EMC Directive, RoHS Directive		
Sensing range	5 m 16.404 ft (without container or pipe)(Note 2)		
Sensing object	ø12 mm ø0.472 in or more liquid which contains water, or opaque object (Note 3)		
Supply voltage	12 to 24 V DC ±10 % Ripple P-P 10 % or less		
Current consumption	Emitter: 25 mA or less, Receiver: 25 mA or less		
Output	NPN open-collector transistor • Maximum sink current: 100 mA • Applied voltage : 30 V DC or less (between output and 0 V) • Residual voltage: 1.5 V or less (at 100 mA sink current) 0.4 V or less (at 16 mA sink current)		PNP open-collector transistor • Maximum source current: 100 mA • Applied voltage: 30 V DC or less (between output and V) • Residual voltage: 1.5 V or less (at 100 mA source current) 0.4 V or less (at 16 mA source current)
	Utilization category	DC-12 or DC-13	
	Output operation	Switchable either Light-ON or Dark-ON	
	Short-circuit protection	Incorporated	
Response time	12 ms or less		
Operation indicator	Orange LED (lights up when the output is ON), located on the receiver		
Stability indicator	Green LED (lights up under stable light received condition or stable dark condition), located on the receiver		
Power indicator	Orange LED (lights up when the power is ON), located on the emitter		
Sensitivity adjuster	Continuously variable adjuster		
Environmental resistance	Pollution degree	3 (Industrial environment)	
	Protection	IP67 (IEC)	
	Ambient temperature	0 to +55 °C +32 to +131 °F (No dew condensation or icing allowed), Storage: -30 to +70 °C -22 to +158 °F	
	Ambient humidity	35 to 85 % RH, Storage: 35 to 85 % RH	
	Ambient illuminance	Incandescent light: 3,000 lx or less at the light-receiving face	
	Voltage withstandability	1,000 V AC for one min. between all supply terminals connected together and enclosure	
	Insulation resistance	20 MΩ, or more, with 250 V DC megger between all supply terminals connected together and enclosure	
	Vibration resistance	10 to 500 Hz frequency, 3 mm 0.118 in double amplitude (20 G max.) in X, Y and Z directions for two hours each	
	Shock resistance	500 m/s ² acceleration (50 G approx.) in X, Y and Z directions three times each	
Emitting element	Infrared LED (modulated)		
Material	Polycarbonate		
Cable	0.2 mm ² 3-core (emitter: 2-core) oil resistant cabtyre cable, 2 m, 6.562 ft long		
Cable extension	Extension up to total 100 m 328.084 ft is possible, for both emitter and receiver, with 0.3 mm ² , or more, cable.		
Weight	Emitter: 45 g approx., Receiver: 50 g approx.		
Accessory	Adjusting screwdriver: 1 pc.		

Notes: 1) Where measurement conditions have not been specified precisely, the conditions used were an ambient temperature of +23 °C **+73.4 °F**.

2) The sensing range shortens depending on the thickness, material, color, etc., of the container or pipe.

3) If there are two slit on both sides, the size of those slit represents the min. sensing object.

FIBER
SENSORSLASER
SENSORSPHOTO-
ELECTRIC
SENSORSMICRO
PHOTO-
ELECTRIC
SENSORSAREA
SENSORSSAFETY LIGHT
CURTAINS/
SAFETY
COMPONENTSPRESSURE /
FLOW
SENSORSINDUCTIVE
PROXIMITY
SENSORSPARTICULAR
USE
SENSORSSENSOR
OPTIONSSIMPLE
WIRE-SAVING
UNITSWIRE-SAVING
SYSTEMSMEASURE-
MENT
SENSORSSTATIC
CONTROL
DEVICESLASER
MARKERS

PLC

HUMAN
MACHINE
INTERFACESENERGY
MANAGEMENT
SOLUTIONSFA
COMPONENTSMACHINE
VISION
SYSTEMSUV
CURING
SYSTEMSSelection
GuideLiquid Leak
DetectionLiquid Level
DetectionWater
DetectionColor Mark
DetectionWafer
Detection

Ultrasonic

Small / Slim
Object DetectionObstacle
Detection**EZ-10**

- FIBER SENSORS
- LASER SENSORS
- PHOTO-ELECTRIC SENSORS
- MICRO PHOTO-ELECTRIC SENSORS
- AREA SENSORS
- SAFETY LIGHT CURTAINS / SAFETY COMPONENTS
- PRESSURE / FLOW SENSORS
- INDUCTIVE PROXIMITY SENSORS
- PARTICULAR USE SENSORS
- SENSOR OPTIONS
- SIMPLE WIRE-SAVING UNITS
- WIRE-SAVING SYSTEMS
- MEASUREMENT SENSORS
- STATIC CONTROL DEVICES
- LASER MARKERS
- PLC
- HUMAN MACHINE INTERFACES
- ENERGY MANAGEMENT SOLUTIONS
- FA COMPONENTS
- MACHINE VISION SYSTEMS
- UV CURING SYSTEMS
- Selection Guide
- Liquid Leak Detection
- Liquid Level Detection
- Water Detection
- Color Mark Detection
- Wafer Detection
- Ultrasonic
- Small / Slim Object Detection
- Obstacle Detection

I/O CIRCUIT DIAGRAMS

NPN output type

I/O circuit diagram

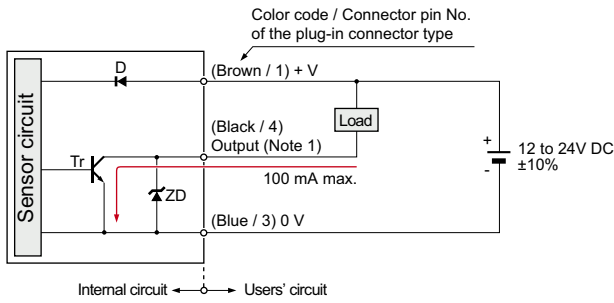

- Notes: 1) The emitter does not incorporate the output.
 2) When the mating cable is connected to the plug-in connector type sensor, the white wire of the mating cable is not connected.

Symbols ... D : Reverse supply polarity protection diode
 Zd: Surge absorption zener diode
 Tr : NPN output transistor

Wiring diagram

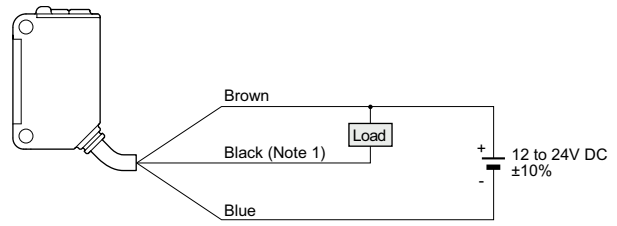

Note: The emitter does not incorporate the black wire.

Connector pin position (plug-in connector type)

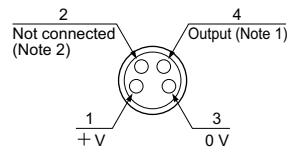

- Notes: 1) The emitter does not incorporate the output.
 2) When the mating cable is connected to the plug-in connector type sensor, the white wire of the mating cable is not connected.

PNP output type

I/O circuit diagram

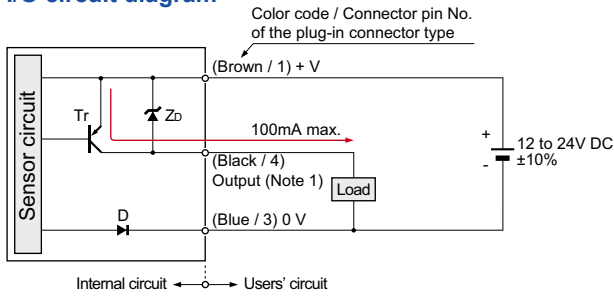

- Notes: 1) The emitter does not incorporate the output.
 2) When the mating cable is connected to the plug-in connector type sensor, the white wire of the mating cable is not connected.

Symbols ... D : Reverse supply polarity protection diode
 Zd: Surge absorption zener diode
 Tr : PNP output transistor

Wiring diagram

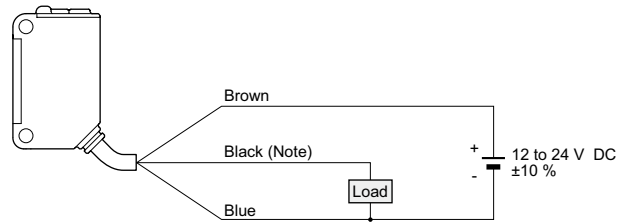

Note: The emitter does not incorporate the black wire.

Connector pin position (plug-in connector type)

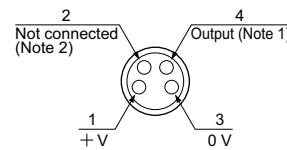

- Notes: 1) The emitter does not incorporate the output.
 2) When the mating cable is connected to the plug-in connector type sensor, the white wire of the mating cable is not connected.

SENSING CHARACTERISTICS (TYPICAL)

Parallel deviation

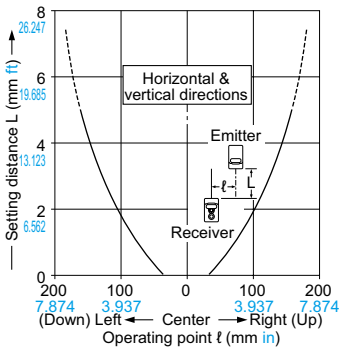

Angular deviation

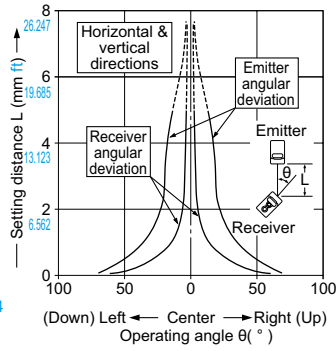

Parallel deviation with round slit masks (ø0.5 mm ø0.020 in)

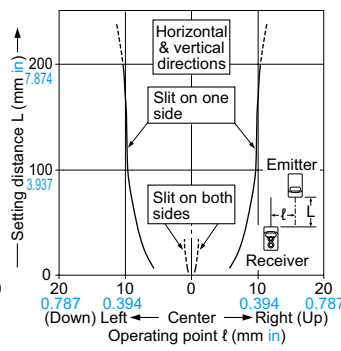

Parallel deviation with round slit masks (ø1 mm ø0.039 in)

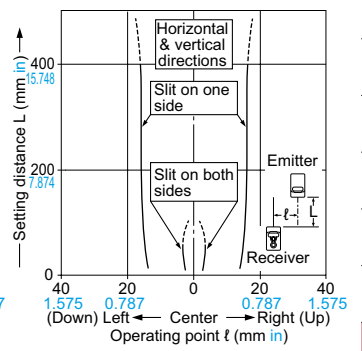

Parallel deviation with round slit masks (ø2 mm ø0.079 in)

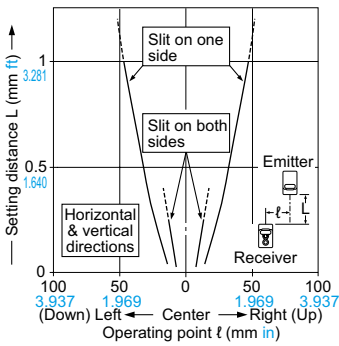

Parallel deviation with rectangular slit masks (0.5 x 6 mm 0.020 x 0.236 in)

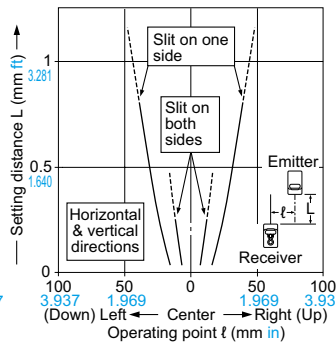

Parallel deviation with rectangular slit masks (1 x 6 mm 0.039 x 0.236 in)

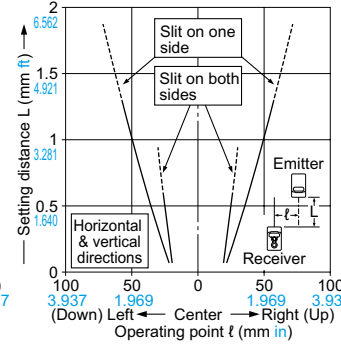

Parallel deviation with rectangular slit masks (2 x 6 mm 0.079 x 0.236 in)

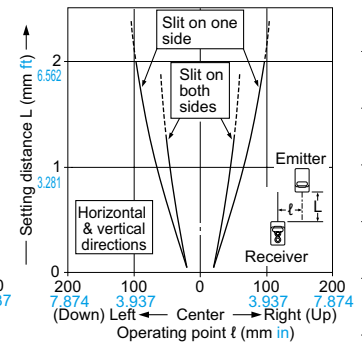

PRECAUTIONS FOR PROPER USE

Refer to p.1552~ for general precautions.



- Never use this product as a sensing device for personnel protection.
- In case of using sensing devices for personnel protection, use products which meet laws and standards, such as OSHA, ANSI or IEC etc., for personnel protection applicable in each region or country.

Mounting

- The tightening torque should be 0.5 N·m or less.

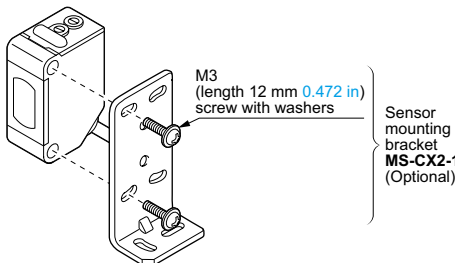

Wiring

- When connecting the mating cable to the plug-in connector type sensor, the tightening torque should be 0.4 N·m or less.

Stability indicator

- The stability indicator (green) lights up when the incident light intensity has sufficient margin with respect to the operation level. If the incident light intensity level is such that the stability indicator lights up, stable sensing can be done without the light received operation and the light interrupted operation being affected by a change in ambient temperature or supply voltage.

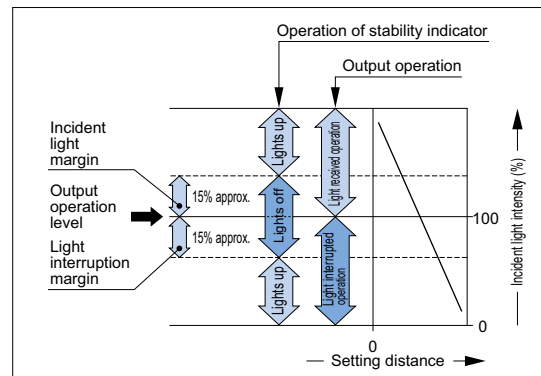

Others

- Because these units use special emitter and receiver elements, they are susceptible to the effects of operating ambient temperature and humidity. Sensitivity adjustment should be performed in the environment in which they will actually be used.
- Do not use during the initial transient time (100 ms) after the power supply is switched on.

FIBER SENSORS

LASER SENSORS

PHOTO-ELECTRIC SENSORS
MICRO PHOTO-ELECTRIC SENSORS

AREA SENSORS

SAFETY LIGHT CURTAINS / SAFETY COMPONENTS

PRESSURE / FLOW SENSORS

INDUCTIVE PROXIMITY SENSORS

PARTICULAR USE SENSORS

SENSOR OPTIONS

WIRE-SAVING UNITS

WIRE-SAVING SYSTEMS

MEASUREMENT SENSORS

STATIC CONTROL DEVICES

LASER MARKERS

PLC

HUMAN MACHINE INTERFACES

ENERGY MANAGEMENT SOLUTIONS

FA COMPONENTS

MACHINE VISION SYSTEMS

UV CURING SYSTEMS

Selection Guide

Liquid Leak Detection

Liquid Level Detection

Water Detection

Color Mark Detection

Wafer Detection

Ultrasonic

Small / Sim Object Detection

Obstacle Detection

EZ-10

- FIBER SENSORS
- LASER SENSORS
- PHOTO-ELECTRIC SENSORS
- MICRO PHOTO-ELECTRIC SENSORS
- AREA SENSORS
- SAFETY LIGHT CURTAINS / SAFETY COMPONENTS
- PRESSURE / FLOW SENSORS
- INDUCTIVE PROXIMITY SENSORS
- PARTICULAR USE SENSORS
- SENSOR OPTIONS
- SIMPLE WIRE-SAVING UNITS
- WIRE-SAVING SYSTEMS
- MEASURE-MENT SENSORS
- STATIC CONTROL DEVICES
- LASER MARKERS
- PLC
- HUMAN MACHINE INTERFACES
- ENERGY MANAGEMENT SOLUTIONS
- FA COMPONENTS
- MACHINE VISION SYSTEMS
- UV CURING SYSTEMS

DIMENSIONS (Unit: mm in)

Refer to p.955~ for dimensions of the universal sensor mounting stand.
The CAD data can be downloaded from our website.

EZ-11 EZ-11-PN Sensor

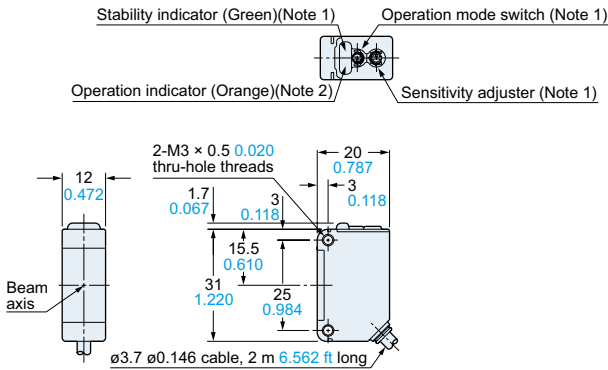

Notes: 1) Not incorporated on the emitter.
2) It is the power indicator (orange) on the emitter.

EZ-11-J EZ-11-PN-J Sensor

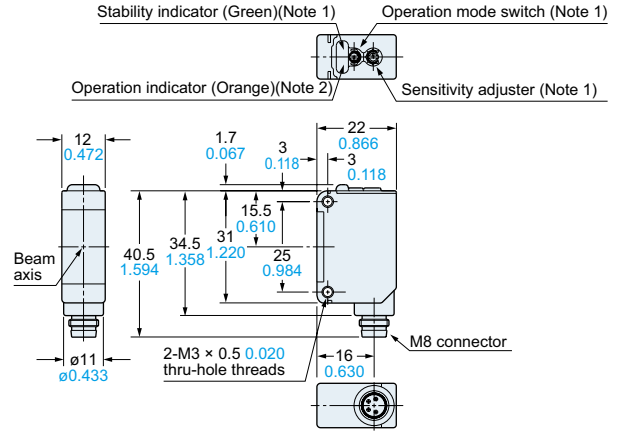

Notes: 1) Not incorporated on the emitter.
2) It is the power indicator (orange) on the emitter.

MS-CX2-1 Sensor mounting bracket (Optional)

Assembly dimensions

Mounting drawing with the receiver of **EZ-11(-PN)**

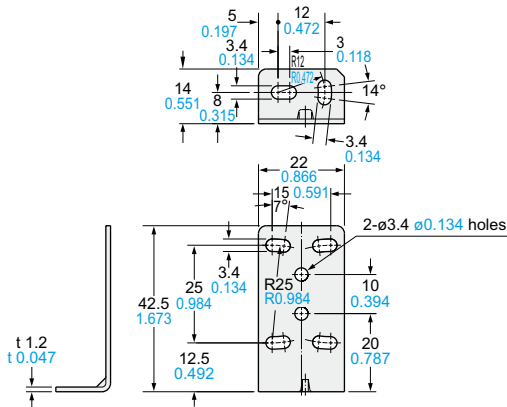

Material: Stainless steel (SUS304)
Two M3 (length 12 mm 0.472 in) screws with washers are attached.

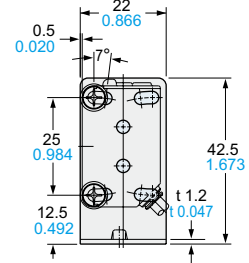
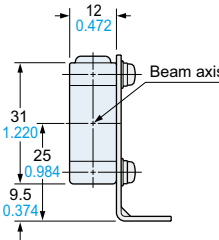
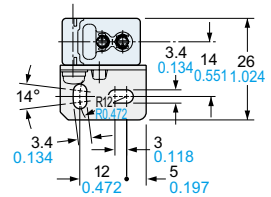

MS-CX2-2 Sensor mounting bracket (Optional)

Assembly dimensions

Mounting drawing with the receiver of **EZ-11(-PN)**

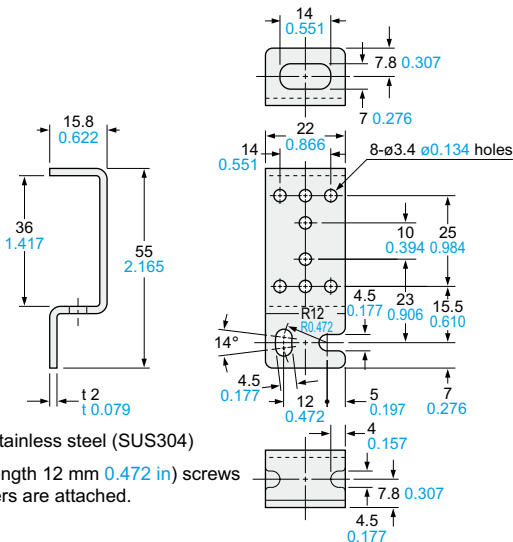

Material: Stainless steel (SUS304)
Two M3 (length 12 mm 0.472 in) screws with washers are attached.

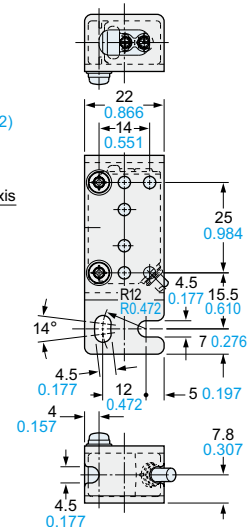
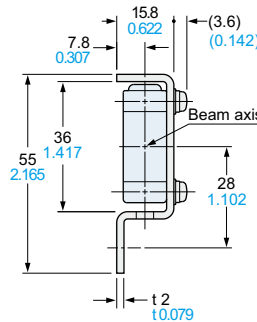

DIMENSIONS (Unit: mm in)

Refer to p.955~ for dimensions of the universal sensor mounting stand.
The CAD data can be downloaded from our website.

MS-CX2-4

Sensor mounting bracket (Optional)

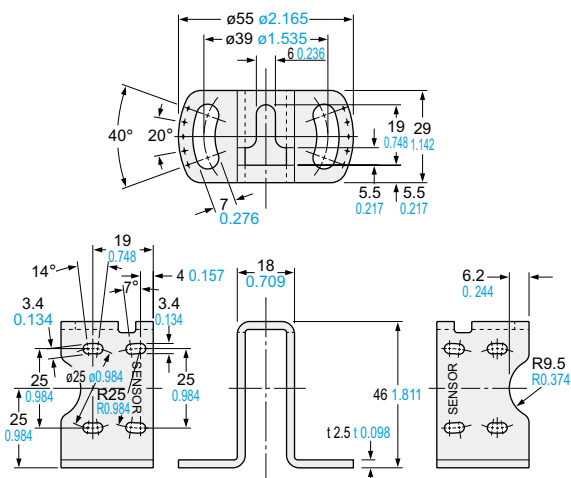

Material: Stainless steel (SUS304)
Two M3 (length 14 mm 0.551 in) screws with washers are attached.

Assembly dimensions

Mounting drawing with the receiver of EZ-11(-PN)

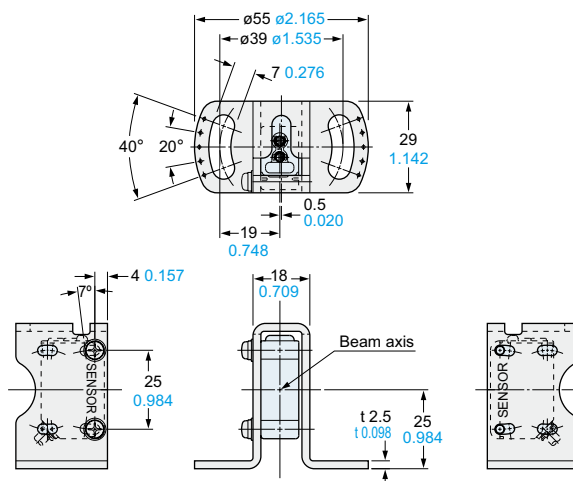

MS-CX2-5

Sensor mounting bracket (Optional)

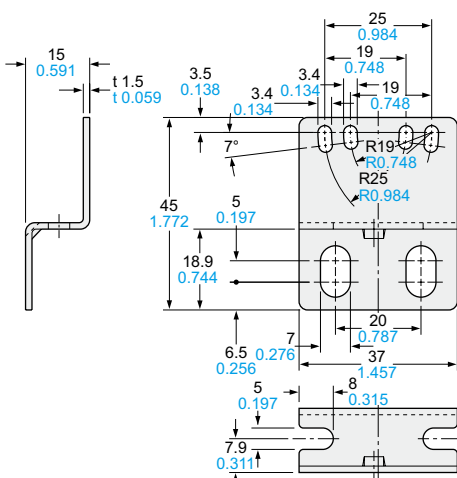

Material: Stainless steel (SUS304)
Two M3 (length 12 mm 0.472 in) screws with washers are attached.

Assembly dimensions

Mounting drawing with the receiver of EZ-11(-PN)

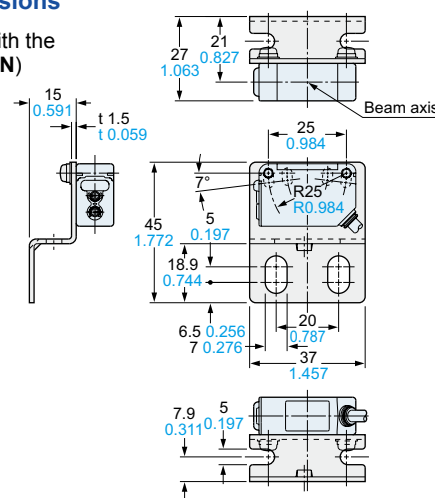

MS-CX-3

Sensor mounting bracket (Optional)

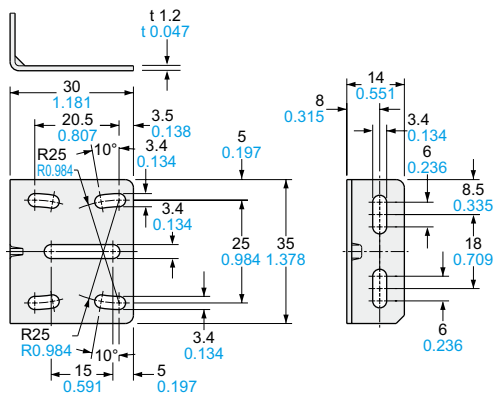

Material: Stainless steel (SUS304)
Two M3 (length 12 mm 0.472 in) screws with washers are attached.

Assembly dimensions

Mounting drawing with the receiver of EZ-11(-PN)

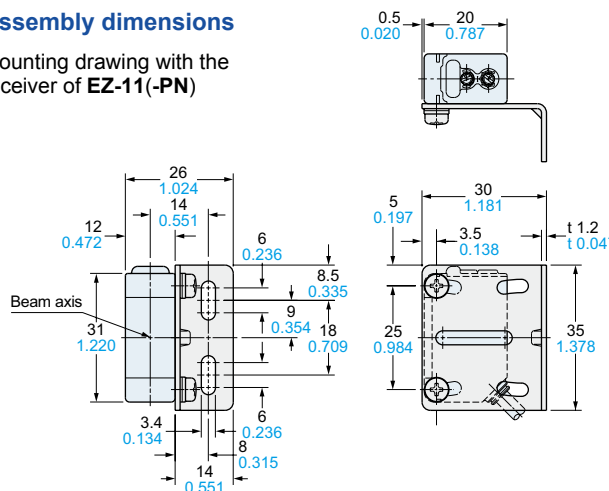

- FIBER SENSORS
- LASER SENSORS
- PHOTO-ELECTRIC SENSORS
- MICRO PHOTO-ELECTRIC SENSORS
- AREA SENSORS
- SAFETY LIGHT CURTAINS / SAFETY COMPONENTS
- PRESSURE / FLOW SENSORS
- INDUCTIVE PROXIMITY SENSORS
- PARTICULAR USE SENSORS
- SENSOR OPTIONS
- SMILE WIRE-SAVING UNITS
- WIRE-SAVING SYSTEMS
- MEASUREMENT SENSORS
- STATIC CONTROL DEVICES
- LASER MARKERS
- PLC
- HUMAN MACHINE INTERFACES
- ENERGY MANAGEMENT SOLUTIONS
- FA COMPONENTS
- MACHINE VISION SYSTEMS
- UV CURING SYSTEMS
- Selection Guide
- Liquid Leak Detection
- Liquid Level Detection
- Water Detection
- Color Mark Detection
- Wafer Detection
- Ultrasonic
- Small / Sim Object Detection
- Obstacle Detection