

# ER-F SERIES

Related Information

- General terms and conditions..... F-3
- Selection guide ..... P.1155~
- Glossary of terms..... P.1591
- General precautions ..... P.1595

**NEW**

No compressed air necessary



[panasonic.net/id/pidsx/global](http://panasonic.net/id/pidsx/global)

## A compact shape for reducing workbench clutter

**Compact size of 150 × 166 × 62 mm 5.906 × 6.535 × 2.441 in**  
**Low-volume fan type also available for various applications**

An ionizer with a 120 mm **4.724 in** fan diameter that has a class leading compact size for reducing workbench clutter and increasing efficiency.  
 Low-volume fan type with a suppressed fan speed of approx. half is available for charge removal in processes which involve handling of small parts or thin films.

\* Graphs represent typical values at 300 mm **11.811 in** from directly in front of air outlet, straight louver, with no filter installed.

Standard fan type ER-F12A

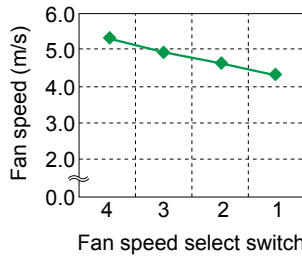

Low-volume fan type ER-F12SA

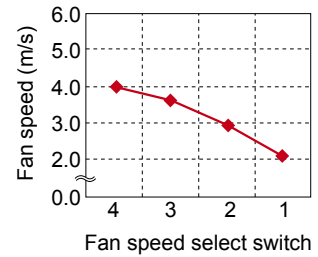

## Two exchangeable louvers to suit your needs

Just simply replace the louver to change configuration between long distance and wide area ionization.  
 The two louvers come with the ionizer main body.

**Straight louver**



Removes charges quickly at long distance

**Angle louver**



Removes charges completely in wide area

- FIBER SENSORS
- LASER SENSORS
- PHOTOELECTRIC SENSORS
- MICRO PHOTOELECTRIC SENSORS
- AREA SENSORS
- SAFETY LIGHT CURTAINS / SAFETY COMPONENTS
- PRESSURE / FLOW SENSORS
- INDUCTIVE PROXIMITY SENSORS
- PARTICULAR USE SENSORS
- SENSOR OPTIONS
- SIMPLE WIRE-SAVING UNITS
- WIRE-SAVING SYSTEMS
- MEASUREMENT SENSORS
- STATIC CONTROL DEVICES
- LASER MARKERS
- PLC
- HUMAN MACHINE INTERFACES
- ENERGY MANAGEMENT SOLUTIONS
- FA COMPONENTS
- MACHINE VISION SYSTEMS
- UV CURING SYSTEMS
- Selection Guide
- Static Removers
- Pulse Air-gun
- Cleaning Box
- Electrostatic Sensor
- ER-X
- ER-TF
- ER-VS02
- ER-VW
- ER-Q
- ER-F

**APPLICATIONS**

**Prevention of static charge in cell production**

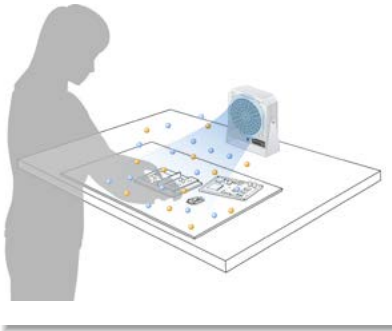

**Equipped with discharge needle fouling detection function**

**New function**

Additionally equipped with discharge needle fouling detection function. When discharge becomes weak due to needle fouling, the DSC indicator will flash for notification.



**Remove the louver for effortless maintenance**

Because the discharge needle unit is attached to the louver, exchange or maintenance of the needles is made easy without touching the main unit. A safe design where once the louver is removed, the high-voltage circuit and the fan will halt.



**ORDER GUIDE**

Type	Appearance	Charge removal time (±1,000 V → ±100 V)	Ion balance	Model No.
Standard fan type		1 sec. approx. (Note 1)	±10 V or less (Note 2)	<b>ER-F12A</b>
Low-volume fan type		1.5 sec. approx. (Note 1)		<b>ER-F12SA</b>

Notes: 1) Typical value at 200 mm 7.874 in from directly in front of air outlet, fan speed MAX, straight louver, with no filter installed.  
 2) Typical value at 300 mm 11.811 in from directly in front of air outlet, fan speed MAX, straight louver, with no filter installed.

**OPTIONS**

Type	Model No.	Description
AC adapter	<b>ER-FAPS-J2</b>	IN: 100-240 V AC 50/60 Hz OUT: 24 V DC, 1.5 A
	<b>ER-FAPS-EX</b> (Note)	Cable length between connector and AC adaptor: 1.8 m 5.905 ft AC cable: 125 V rated (an accessory to <b>ER-FAPS-J2</b> only)
Discharge needle unit	<b>ER-F12ANT</b>	Unit with tungsten needles (1 pc.)
Air filter	<b>ER-F12FX5</b>	Replacement filter (5 pcs. per set)

Note: Please prepare an AC cable separately as it is needed.

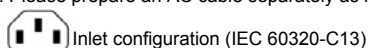

FIBER SENSORS

LASER SENSORS

PHOTO-ELECTRIC SENSORS

MICRO PHOTO-ELECTRIC SENSORS

AREA SENSORS

SAFETY LIGHT CURTAINS / SAFETY COMPONENTS

PRESSURE / FLOW SENSORS

INDUCTIVE PROXIMITY SENSORS

PARTICULAR USE SENSORS

SENSOR OPTIONS

SMILE WIRE-SAVING UNITS

WIRE-SAVING SYSTEMS

MEASUREMENT SENSORS

STATIC CONTROL DEVICES

LASER MARKERS

PLC

HUMAN MACHINE INTERFACES

ENERGY MANAGEMENT SOLUTIONS

FA COMPONENTS

MACHINE VISION SYSTEMS

UV CURING SYSTEMS

Selection Guide

Static Removers

Pulse Air-gun

Cleaning Box

Electrostatic Sensor

**ER-X**

**ER-TF**

**ER-VS02**

**ER-VW**

**ER-Q**

**ER-F**

### SPECIFICATIONS

Type	Standard fan type	Low-volume fan type
Item	ER-F12A	ER-F12SA
CE marking directive compliance	EMC Directive, RoHS Directive	
Charge removal time ( $\pm 1,000\text{ V} \rightarrow \pm 100\text{ V}$ )	1 sec. approx. (Note 2)	1.5 sec. approx. (Note 2)
Ion balance	$\pm 10\text{ V}$ or less (Note 3)	
Power supply voltage	24 V DC $\pm 10\%$	
Power consumption	700 mA or less	400 mA or less
Discharge method	High-frequency AC method	
Discharge output voltage	$\pm 2\text{ kV}$ approx.	
Max. fan speed	5.3 m/s (Note 3)	4.0 m/s (Note 3)
Max. fan volume	3.68 m <sup>3</sup> /min.	2.50 m <sup>3</sup> /min.
Error output	NPN open-collector transistor • Max. sink current: 50 mA • Applied voltage: 30 V DC or less (between output terminal and 0 V) • Residual voltage: 1 V or less (at input current of 50 mA)	
Output operation	OFF when discharge error or fan error detected Normally ON	
Short-circuit protection	Incorporated	
Discharge halt input	Discharge halt: Short-circuited to 0 V Discharge (operation start): Open	
Indicators	Discharge error (Red), Fan error (Red), Power (Green), Discharge (Green)	
Ozone generation amount	0.04 ppm or less (Note 2)	
Ambient temperature	0 to +50 °C +32 to +122 °F (No dew condensation allowed), Storage: -10 to +65 °C +14 to +149 °F	
Ambient humidity	35 to 65 % RH (No dew condensation allowed), Storage: 35 to 65 % RH	
Grounding method	C (capacitor) grounding	
Material	Enclosure: ABS, Louver: ABS, Discharge needle unit: PBT, Discharge needle: Tungsten, Bracket: SPHC	
Weight	Net weight: 790 g approx.	
Accessories	Straight louver: 1 pc. (Note 4), Angle louver: 1 pc., Caution label: 1 set, Rubber cushion: 1 pc.	

Notes: 1) Where measurement conditions have not been specified precisely, the conditions used were an ambient temperature of +20 °C +68 °F.  
 2) Typical value at 200 mm 7.874 in from directly in front of air outlet, fan speed MAX., straight louver, with no filter installed.  
 3) Typical value at 300 mm 11.811 in from directly in front of air outlet, fan speed MAX., straight louver, with no filter installed.  
 4) The discharge needle unit is loaded on the straight louver before shipment.

### I/O CIRCUIT AND WIRING DIAGRAMS

#### I/O circuit diagram

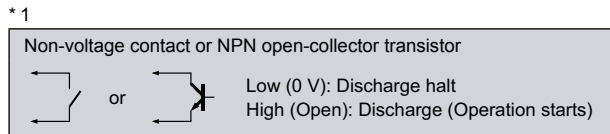
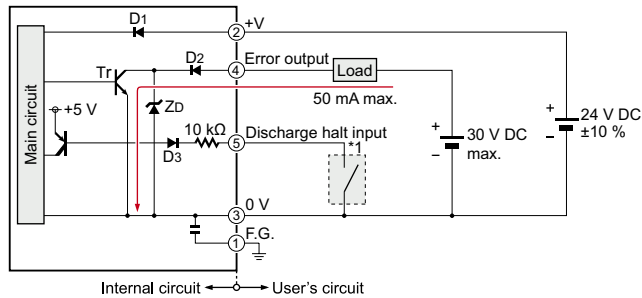

Symbols ...  
 D1 : Reverse supply polarity protection diode  
 D2 : Output protection diode  
 D3 : Input protection diode  
 ZD : Surge absorption zener diode  
 Tr : NPN output transistor

#### Connector terminal arrangement

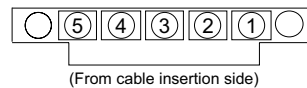

Terminal No.	Color code
①	F.G.
②	+V
③	0 V
④	Error output
⑤	Discharge halt input

#### Recommended wiring cable

Compatible wire: 25 AWG to 12 AWG (nominal cross-sectional area: 0.16 to 3.3 mm<sup>2</sup>)  
 Wire stripping length: 7 mm 0.276 in (see below)

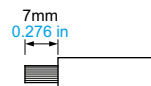

Note: Do not solder-plate the ends of wires being connected to connectors. Doing so may result in loosening of tightened screws, causing the wire to come loose.

FIBER SENSORS  
 LASER SENSORS  
 PHOTO-ELECTRIC SENSORS  
 MICRO PHOTO-ELECTRIC SENSORS  
 AREA SENSORS  
 SAFETY LIGHT CURTAINS / SAFETY COMPONENTS  
 PRESSURE / FLOW SENSORS  
 INDUCTIVE PROXIMITY SENSORS  
 PARTICULAR USE SENSORS  
 SENSOR OPTIONS  
 SIMPLE WIRE-SAVING UNITS  
 WIRE-SAVING SYSTEMS  
 MEASUREMENT SENSORS  
 STATIC CONTROL DEVICES  
 LASER MARKERS  
 PLC  
 HUMAN MACHINE INTERFACES  
 ENERGY MANAGEMENT SOLUTIONS  
 FA COMPONENTS  
 MACHINE VISION SYSTEMS  
 UV CURING SYSTEMS  
 Selection Guide  
 Static Removers  
 Pulse Air-gun  
 Cleaning Box  
 Electrostatic Sensor  
 ER-X  
 ER-TF  
 ER-VS02  
 ER-VW  
 ER-Q  
 ER-F

## CHARGE REMOVAL CHARACTERISTICS (TYPICAL)

Measured using a 150 × 150 mm 5.906 × 5.906 in CPM (charge plate monitor) (At center of CPM)

### ER-F12A ER-F12SA

Solid lines in the graphs show **ER-F12A**. Dotted lines show **ER-F12SA**.

**Charge removal field**  
(Fan speed MAX., straight louver is mounted)

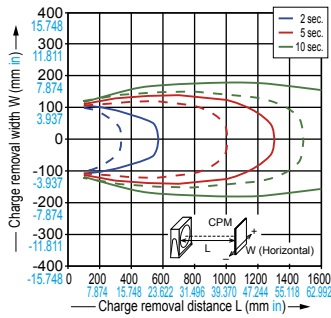

**Charge removal field**  
(Fan speed MAX., angle louver is mounted)

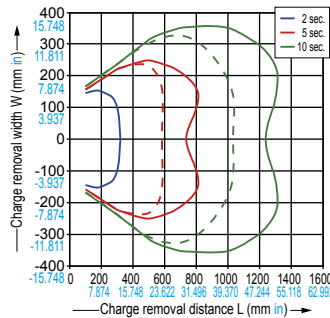

## PRECAUTIONS FOR PROPER USE

Refer to p.1595 for general precautions.



- Never use this product in a device for personnel protection.
- In case of using sensing devices for personnel protection, use products which meet laws and standards, such as OSHA, ANSI or IEC etc., for personnel protection applicable in each region or country.
- Do not use this product in places where there may be a danger of flammable or combustible items being present.
- If this product is used in an airtight room, ozone emitted from this product may be detrimental. Therefore, in order for this product to be used in an airtight room, be sure to keep the room ventilated.
- Since the tip of the discharge needle is sharp, take sufficient care in handling the discharge needle.
- Clean the discharge needle regularly, otherwise optimum charge removal performance may not be obtained and fire or operating problems may occur.
- Be sure to ground the frame ground (F.G.) terminal.

## DIMENSIONS (Unit: mm in)

The CAD data can be downloaded from our website.

### ER-F12A ER-F12SA

Ionizer main unit

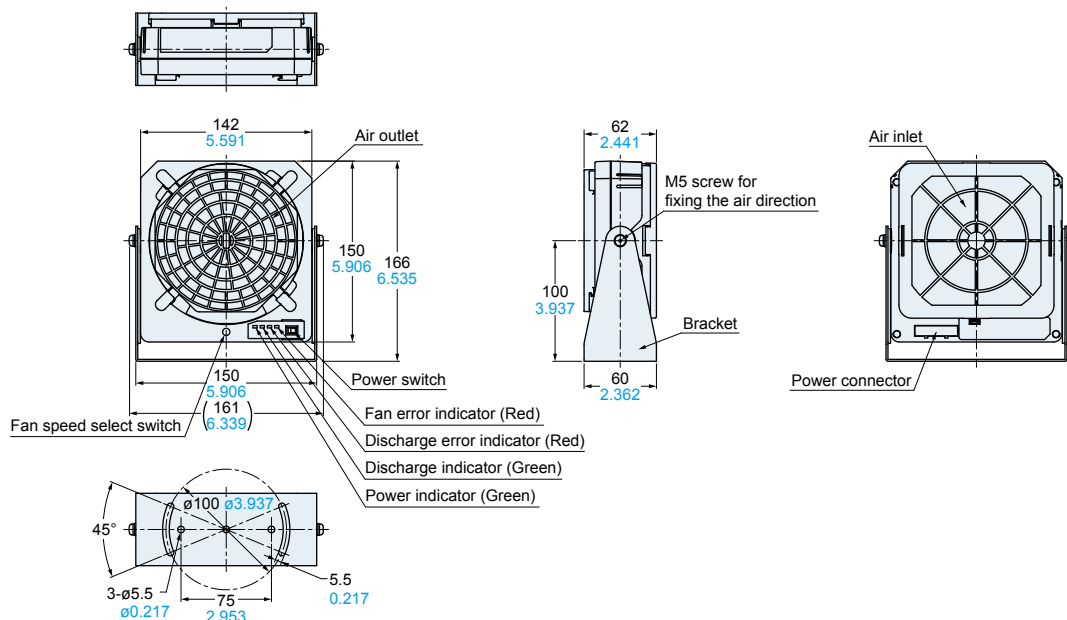

FIBER SENSORS

LASER SENSORS

PHOTO-ELECTRIC SENSORS

MICRO PHOTO-ELECTRIC SENSORS

AREA SENSORS

SAFETY LIGHT CURTAINS / SAFETY COMPONENTS

PRESSURE / FLOW SENSORS

INDUCTIVE PROXIMITY SENSORS

PARTICULAR USE SENSORS

SENSOR OPTIONS

SIMPLE WIRE-SAVING UNITS

WIRE-SAVING SYSTEMS

MEASUREMENT SENSORS

STATIC CONTROL DEVICES

LASER MARKERS

PLC

HUMAN MACHINE INTERFACES

ENERGY MANAGEMENT SOLUTIONS

FA COMPONENTS

MACHINE VISION SYSTEMS

UV CURING SYSTEMS

Selection Guide

Static Removers

Pulse Air-gun

Cleaning Box

Electrostatic Sensor

ER-X

ER-TF

ER-VS02

ER-VW

ER-Q

ER-F