

454

2D displacement sensor

LS series



Line beam for fast, accurate measuring of height and width

- | Linearity of $\pm 0.1\%$ F.S.
- | Sampling period of 0.5 ms (max. speed)
- | 2-dimensional measurements at a significantly low cost



Related products

High performance measurement sensor
CDX
 ● P.438

Selection table

Type	Shape	Measurement distance	Width of view	Spot size	Model	
					NPN type	PNP type
2D reflective type		100 \pm 25 mm	17 to 27 mm	0.3 x 32 mm	LS-100CN	LS-100CP

Options

Main cable



Serves as the power, I/O, and analog output cable.

Because this cable is not included, please select from the following when ordering.

STL-0H12-G02M

Cable length: 2 m

STL-0H12-G05M

Cable length: 5 m

STL-0H12-G10M

Cable length: 10 m

Specifications: $\phi 6$ 12-wire x 0.2 mm²

PC connection cable (USB)



Connects to the sensor and PC when using PC software.

Serves as a conversion cable for RS-485 and USB.

DSL-DH06-G1M8

Cable length: 1.8 m

RS-485 communication cable (discrete wire)



Discrete wire cable for RS-485 communication.

DOL-SH06-G02M

Cable length: 2 m

DOL-SH06-G05M

Cable length: 5 m

DOL-SH06-G10M

Cable length: 10 m



Line beam provides high-speed, high-precision measurement of height and width

These sensors can be used on any manufacturing line to perform the shape measurements required for quality management of parts and materials. With the FASTUS LS series, high-accuracy 2D measurement sensor achieved both super cost effectiveness and significantly high speed measurement that conventional 1D measurement sensors can't achieve. These are next generation 2D displacement sensors that have created a whole new category in part measurement.



Repeat accuracy

Height (Z axis) **2 μ m**

• With an average height measurement of a white workpiece with a center width of 5 mm

Resolution

Width (X axis) **25 μ m**

Linearity

$\pm 0.1\%$ of F.S.

Sampling period

Max. speed **0.5 ms**

Total sampling period **5 ms**

High speed, compact size and low price are achieved using Optex-FA original method

Employing a mathematical operation known as a projection transformation, which converts a captured image into distance, allows both height and width to be measured with a high degree of precision. Also, by employing Optex-FA original method in which projection transformations, normally performed on all pixels in the case of competitors' products, are performed after triangulation, processing levels are significantly compressed, allowing high speed to be achieved. Furthermore, a more compact and low cost product has been realized by making processors smaller size.

Comparison of processing flow

*With 800 x 800 receiver element

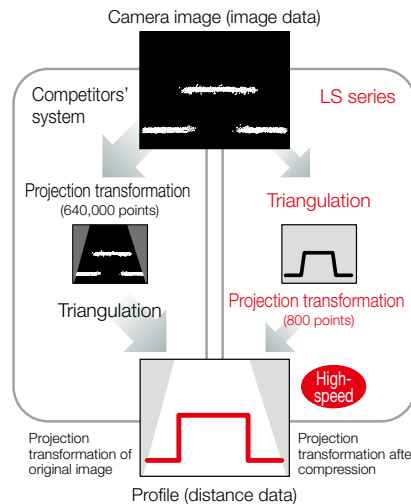

Photoelectric Sensors

Specialized Photoelectric Sensors

Laser Displacement Sensors

2D Displacement Sensor

CDX

CDA

LS

CD22

CD33

CD4

CD5

UQ1-01

UQ1-02

Photoelectric Sensors

Specialized Photoelectric Sensors

Laser Displacement Sensors

2D Displacement Sensor

CDX

CDA

LS

CD22

CD33

CD4

CD5

UQ1-01

UQ1-02

2D displacement sensor LS series

Applications

Brake pad part height measurements

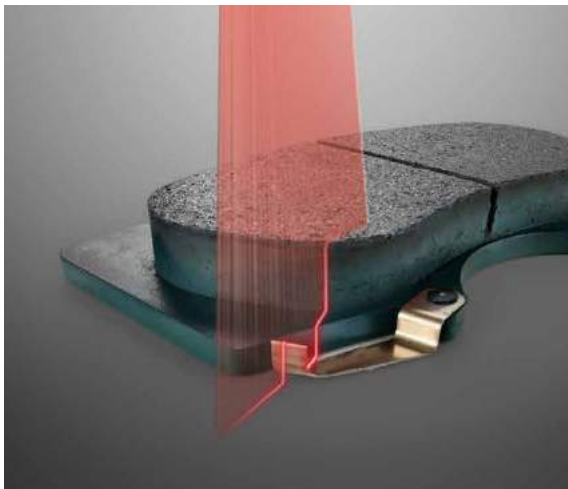

The relative position (height) of the tip of a brake pad wear indicator and the brake pad surface is measured.



Substrate overlap feed detection

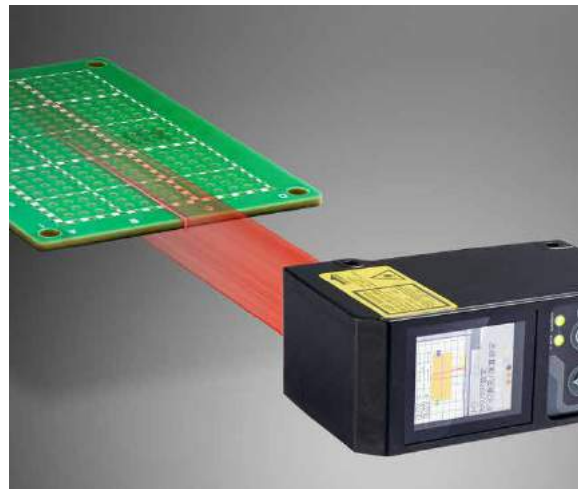

As opposed to a displacement sensor in which thickness measurements are performed using two substrates on top of one another, LS series sensors can measure one substrate from the lateral direction, enabling feasibility in terms of both mounting and designing.

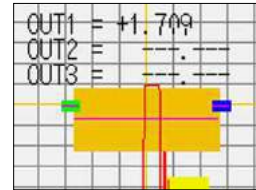

Inspection for sealant application position/amount



By measuring both width and height immediately following application, feedback can be quickly provided regarding the appropriate application amount and position.

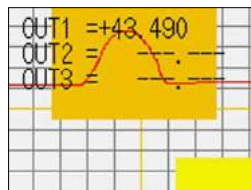

Inspection of vehicle door gaps/height differences



In order to confirm accuracy when installing doors on vehicles, non-contact measurements are performed quickly using the gaps and height differences between the doors and vehicle body.

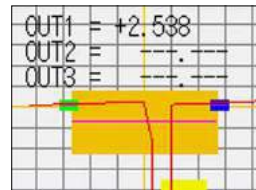

Photoelectric Sensors

Specialized Photoelectric Sensors

Laser Displacement Sensors

2D Displacement Sensor

CDX

CDA

LS

CD22

CD33

CD4

CD5

UQ1-01

UQ1-02

Various measurement functions

Height

Average, peak, and bottom heights can be measured. Average values, max. values, and min. values of a profile within an area are output.

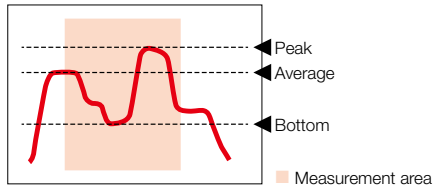

Position

Peak, bottom, and edge positions can be measured.

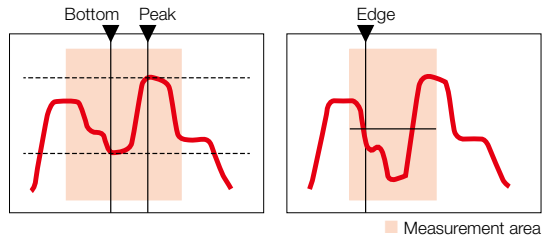

Width

Groove and height difference widths can be measured. Profile widths are detected using the center position in the height direction of the area.

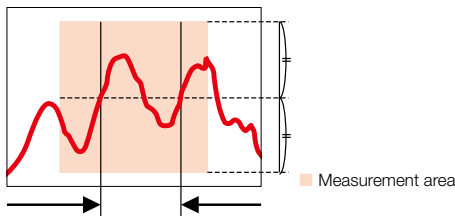

Edge count

The number of times the center of the area's height is crossed is counted. Use is also possible for pin counts, etc.

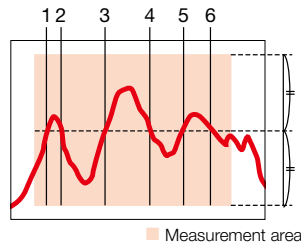

Tilt (°)

A straight line approximating the profile is created and its tilt is measured. (Unit: °) The angles of both sides of grooves and protrusions are measured and calculated.

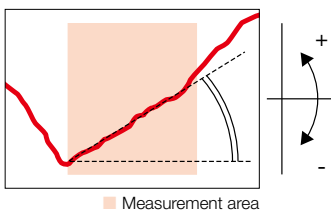

Area (mm²)

The area between an area and a profile is calculated. Measuring the "↑" portion reveals the cross-section of the protrusion, while the "↓" portion reveals the cross-section of the concave.

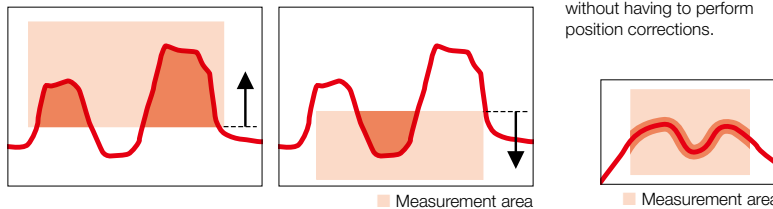

Line length

The profile length is measured. Because the same value will be achieved even if the position is changed, usage is possible without having to perform position corrections.

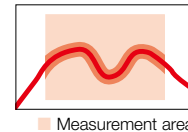

Diameter

The diameter of the approximate bending line of the measured results is measured. This can be used for calculating the diameters cylinders, protrusions or grooves.

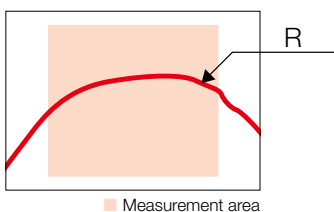

A wide-range of measurement variations using area calculations

■ Example of height difference measurement
Height is measured at two areas (top and bottom surfaces) from which the height difference can be measured by subtracting. Small unevenness and variations can be ignored and it is possible to perform more stable measurements than with 1D displacement sensors.

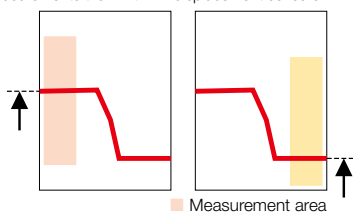

■ Example of angle measurement
Tilting to the left or right is measured using two areas from which the angle can be measured by subtracting. The external angles of both grooves and protrusions can be measured correctly.

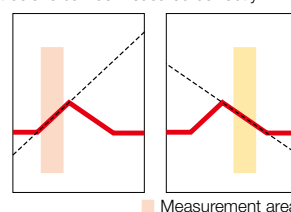

Photoelectric Sensors

Specialized Photoelectric Sensors

Laser Displacement Sensors

2D Displacement Sensor

CDX

CDA

LS

CD22

CD33

CD4

CD5

UQ1-01

UQ1-02

2D displacement sensor **LS** series

Functions for highly accurate and stable measurements

AUTO function

Auto Adjust



Simply set the workpiece and click "Auto Adjust" to automatically select the optimum shutter speed to suit the quantity of light receiving from the workpiece.

Profile correction function

The LS series is equipped with a profile correction function that corrects workpiece position deviation in terms of height, position and tilting when compared to the registered master and is effective for production lines that create deviation of the workpieces.

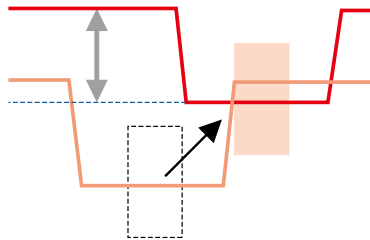

Four camera modes

The LS series incorporates four camera modes for stable imaging: a standard, high resolution mode; high speed mode, which captures images at four times the standard speed; high dynamic range (HDR) mode, which increases the range of brightness; and noise reduction (NR) mode.



HDR mode (High dynamic range)



HDR mode creates a composite image from two images taken with different shutter times. This function is useful for workpieces with areas of high contrast such as reflective metal surfaces.

NR mode (Noise reduction)

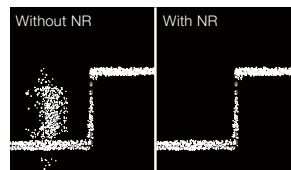

NR mode creates a composite image by amplifying an image of the bright areas and combining it with an image of the dark areas. This feature reduces noise such as ambient light.

Easy setup

Easy setup

The LS series can be configured in four easy steps: camera imaging, area measurement and area calculation, and result judgment and output.

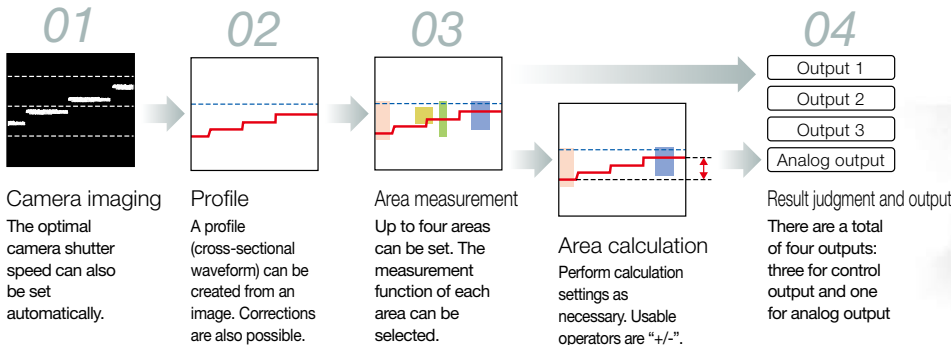

Easy setup PC software

LS-Navigator (included with delivery)

With delivery, the LS series comes with software that lets you easily configure settings from a PC.

- Easy configuration of capturing area and measurement area settings
- All settings can be configured via RS-485 communication
- Profiles can also be output with high precision
- No need for expensive dedicated displays

*PC connector cable (optional) required separately.

CD-ROM included
Can also be downloaded from the homepage.

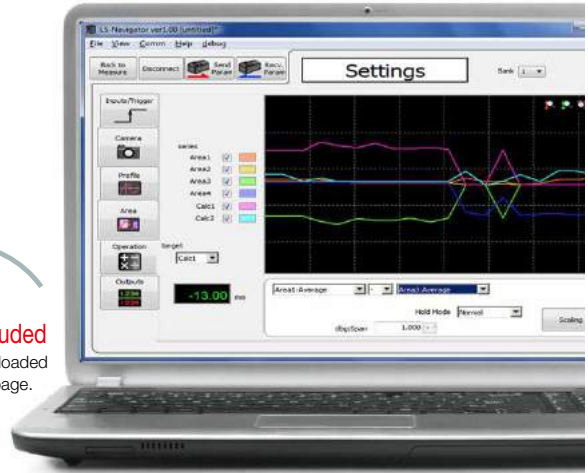

*Screen content and layout subject to change.

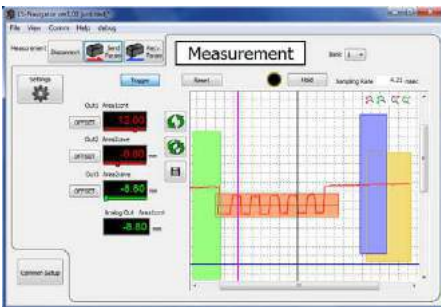

Main screen

The measurement results and profile can be confirmed. Confirmation of Hold or Trigger can also be performed using this screen.

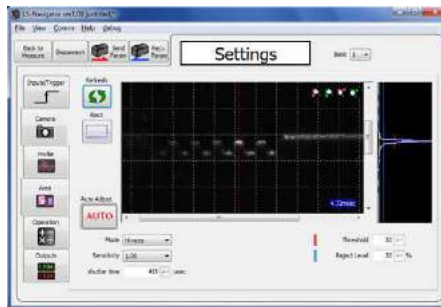

Measurement screen

Setting screens are shown in categories using the tabs on the left side of the screen. Setting is completed by selecting these tabs starting from the top.

Storage function

Measurement result and "Profile + Measurement result" can be stored and those data can be sent to PC through RS-485 communication. All the sampling data can be obtained regardless of the communication speed, and by using the LS-Navigator, it is possible to obtain data without the use of programs.

Because obtained data can be saved in CSV format, it can be accessed using spreadsheet software, etc.

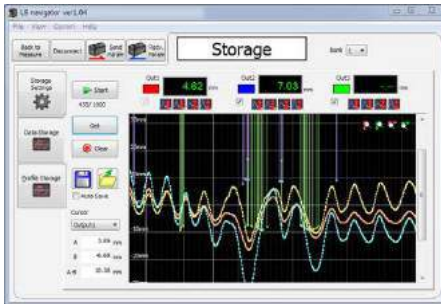

Data storage screen

Stored measured values (areas 1 to 4, calculations 1 to 2) are displayed in the graph. The values of each position can be checked as desired using the cursor. Up to 65535 pieces of measurement data can be saved.

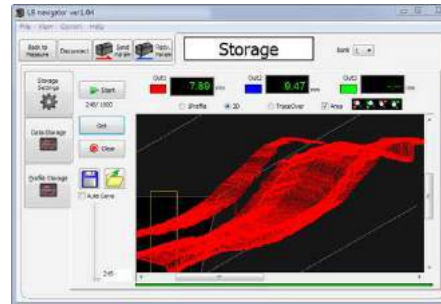

Profile storage screen

Stored profiles can be displayed in 3D. Up to 8000 profiles can be stored.

Photoelectric Sensors

Specialized Photoelectric Sensors

Laser Displacement Sensors

2D Displacement Sensor

CDX

CDA

LS

CD22

CD33

CD4

CD5

UQ1-01

UQ1-02

460

Laser Displacement Sensors

Photoelectric Sensors

Specialized Photoelectric Sensors

Laser Displacement Sensors

2D Displacement Sensor

CDX

CDA

LS

CD22

CD33

CD4

CD5

UQ1-01

UQ1-02

2D displacement sensor LS series

Measurement range

Emitted/received light range

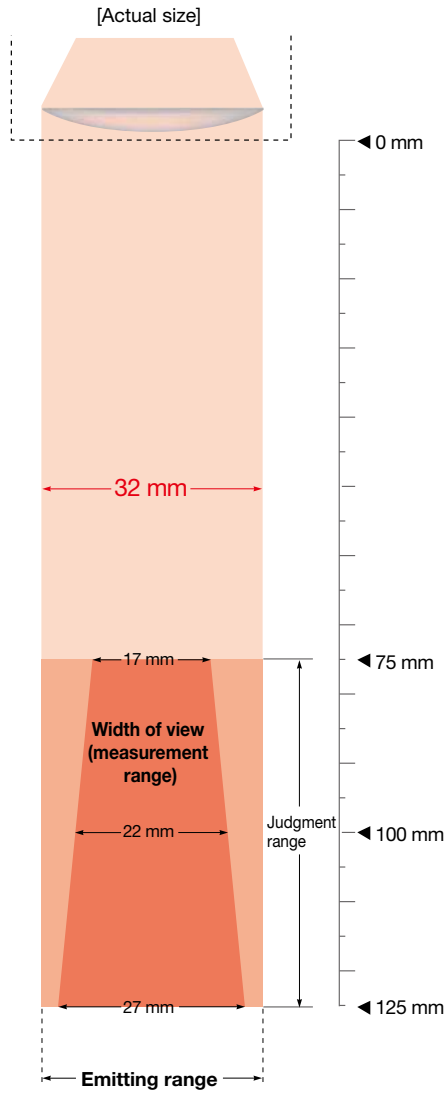

Z axis material linearity (typical value)

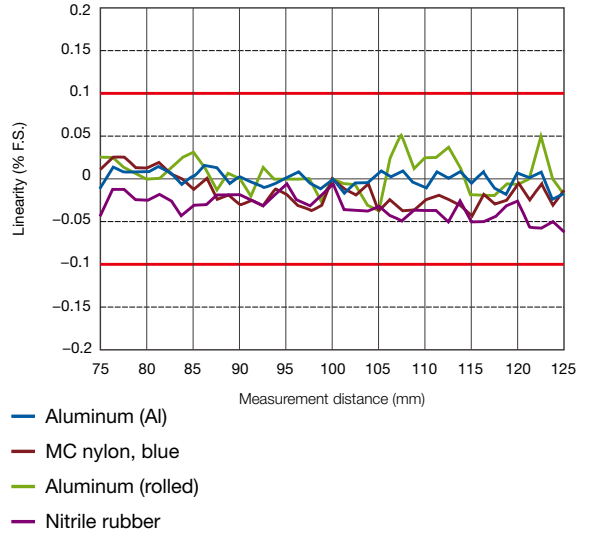

Photoelectric
SensorsSpecialized
Photoelectric
SensorsLaser
Displacement
Sensors2D
Displacement
Sensor

CDX

CDA

LS

CD22

CD33

CD4

CD5

UQ1-01

UQ1-02

Specifications

Type		Parallel line emitting reflective type
Model	NPN	LS-100CN
	PNP	LS-100CP
Measurement distance		100 ±25 mm
Width of view (at measuring distance)		17 mm (at 75 mm) to 27 mm (at 125 mm)
Light source		Red semiconductor laser, wavelength: 655 nm, max. output: 1 mW
Laser class	IEC/JIS	Class 2
	FDA	Class 2 ^{*1}
Spot size ^{*2}		Approx. 0.3 × 32 mm
Linearity	Z axis	±0.1% of F.S.
Repeat accuracy ^{*3}	Z axis	2 μm
Resolution ^{*4}	X axis	25 μm
Sampling period		Typical value: 5 ms (when measuring the whole view in “Hi-res” mode), max. speed: 0.5 ms
Display		Dot matrix display
Indicators		Power indicator (green), laser emission indicator (green)
External input		Selectable from bank, trigger, hold, reset, laser OFF, and offset
Control output		3 NPN/PNP open collector outputs, max. 100 mA/30 VDC (max. residual voltage: 1.8 V)
Analog output		4 to 20 mA, out of measurement range: 24 mA (max. load impedance: 300 Ω)
Communication I/F		RS-485 half duplex (9.6 kbps to 4.0 Mbps)
Temperature drift (typical example)		0.05% of F.S./°C
Supply voltage		12 to 24 VDC (±10%, including -5% ripple)
Current consumption ^{*5}		Max. 180 mA
Environmental resistance	Degree of protection	IP67
	Ambient temperature/humidity	-10 to +40°C/35 to 85% RH (no condensation or freezing)
	Storage temperature/humidity	-20 to +60°C/35 to 85% RH (no condensation or freezing)
	Ambient illuminance	Sunlight: 10000 lx or less, high-frequency lamp: 3000 lx or less
	Vibration resistance	10 to 55 Hz; double amplitude 1.5 mm; 2 hours in each of the X, Y, and Z directions
	Shock resistance	Approx. 50 G (500 m/s ²), 3 times in each of the X, Y, and Z directions
Applicable regulations		EMC directive (2004/108/EC) / FDA regulations (21 CFR 1040.10)
Applicable standards		EN 60947-5-7
Warm-up time		Approx. 30 minutes
Material		Main unit: Zinc die-casting, PC/emitting and receiving parts: Glass
Weight		Approx. 300 g

*1 In accordance with the FDA provisions of Laser Notice No. 50, the laser is classified as Class 2 per the IEC 60825-1 standard.

*2 Defined with center strength 1/e² (13.5%) at the center of measurement range. There may be leak light other than the specified spot size. The sensor may be affected when there is a highly reflective object close to the detection area.

*3 With an average height measurement of a white workpiece with a center width of 5 mm, smoothing performed 8 times, moving average performed 32 times (with the default settings)

*4 With a measurement distance of 75 mm

*5 Supply voltage: 24 VDC not including the control output load current and including the analog output

Photoelectric Sensors

Specialized Photoelectric Sensors

Laser Displacement Sensors

2D Displacement Sensor

CDX

CDA

LS

CD22

CD33

CD4

CD5

UQ1-01

UQ1-02

2D displacement sensor **LS** series

I/O circuit diagram

Inputs

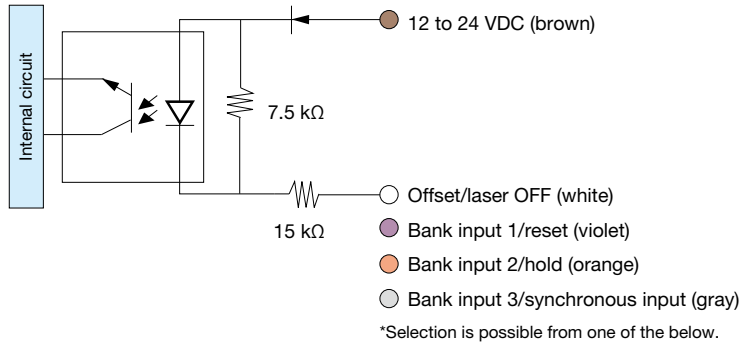

Control output (NPN type)

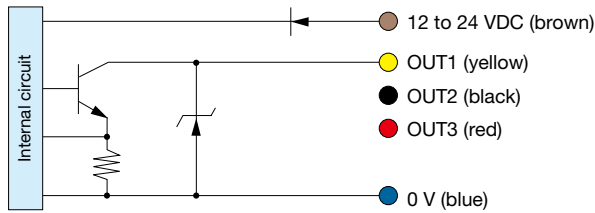

Control output (PNP type)

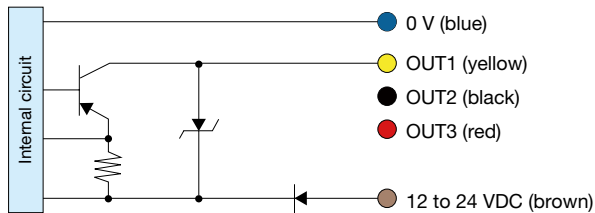

Analog output

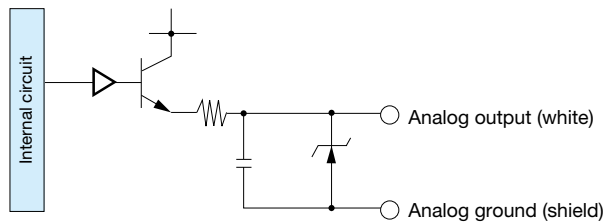

RS-485

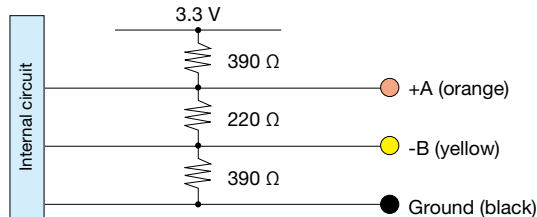

Dimensions

Sensor

■ LS-100C □

(Unit: mm)

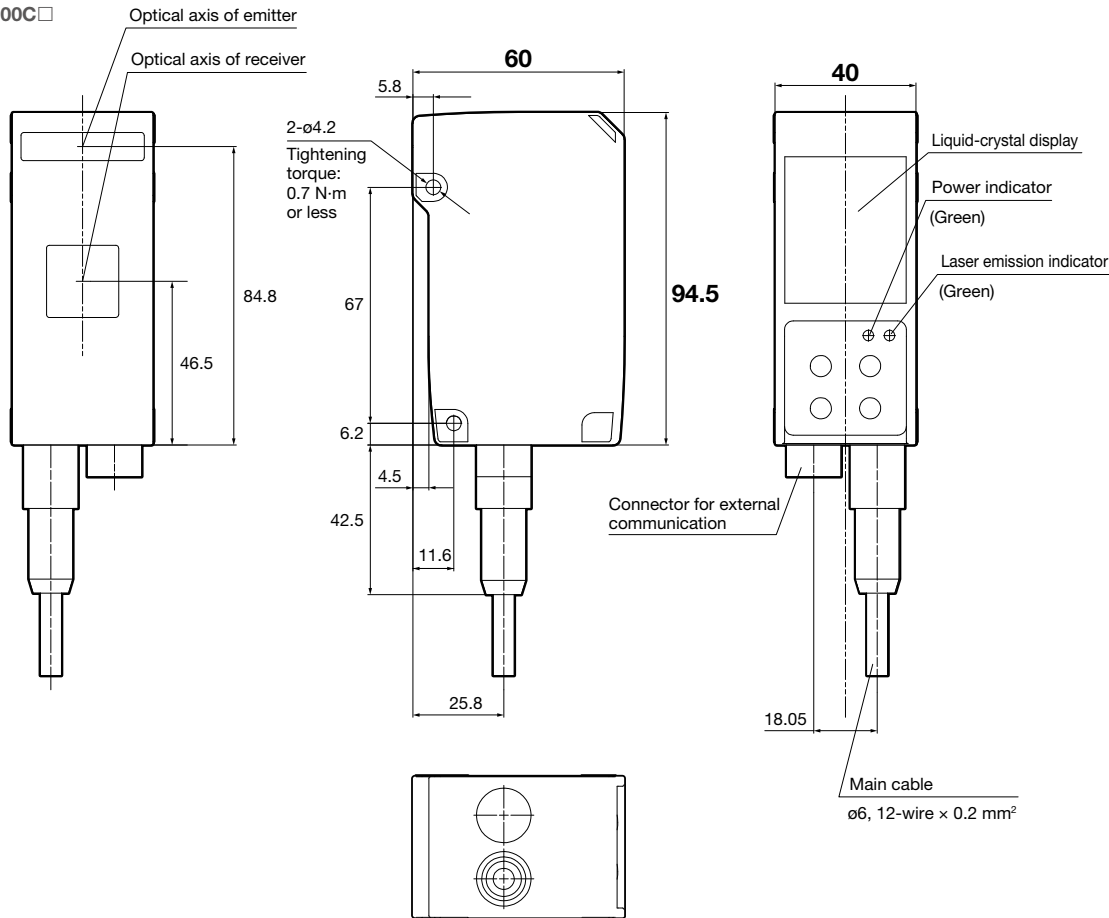

Photoelectric Sensors

Specialized Photoelectric Sensors

Laser Displacement Sensors

2D Displacement Sensor

CDX

CDA

LS

CD22

CD33

CD4

CD5

UQ1-01

UQ1-02

Precautions for laser use

This product emits a Class 2 visible laser beam that is compliant with JIS C6802/IEC/FDA laser safety standards. Labels for applicable standards are affixed or attached to the sides of the sensor.

Type of laser used in this product

Type	Red semiconductor laser
Wavelength	655 nm
Output	1 mW (Max.)

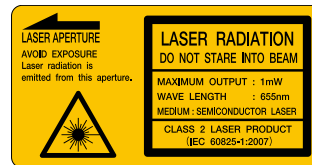

● Export to the United States

If you install this product in a piece of machinery that will then be exported to the United States, it is necessary to follow laser standards as stipulated by the American Food and Drug Administration (FDA).

This product has already been submitted to the CDRH (Center for Devices and Radiological Health). If exporting to the United States, apply the attached seal to the product or replace the seal.

Notes for sensor usage



Warning

Do not look directly at the laser or intentionally aim the laser beam in another person's eyes. Doing so may cause damage to the eyes or health.