



Photoelectric Sensor K SERIES

- KT-700□□
- KD-40□□
- KR-250□□
- KD-L09□□
- KR-Q50□□
- KR-Q50N(W)
- KR-Q300NW
- KR-Q150□□W

INSTRUCTION MANUAL

- Confirm if the item meets your needs.
- Before the use, you should first thoroughly read this manual and operate correctly as mentioned.
- You should keep this manual at hand for proper use.

SPECIFICATIONS

	Through beam	Diffused reflection	Retro reflection (with polarizing filter)	Limited range	Transparent model			
Cord type	KT-700N(P)	KD-40N(P)	KR-250N(P)	KD-L09N(P)	KR-Q50N(P)	KR-Q50NW	KR-Q150N(P)W	KR-Q300NW
Connector type	KT-700CN(CP)	KD-40CN(CP)	KR-250CN(CP)	KD-L09CN(CP)	KR-Q50CN(CP)			
Detecting distance	7m	40cm*1	2.5m	10~90mm*2	50cm (10~50cm*3)	150cm (50~150cm*3)	250cm (100~250cm*3)	
Min detectable object	φ7mm	—	φ40mm	—	φ2.5mm (Opaque object)	φ40mm (Opaque object)		
Supply voltage	DC 10~30V							
Current consumption	35mA max				30mA max.			
Response time	1ms max.				0.7ms max.			
Hysteresis	—	20%max.(at 40cm)	—	20%max(at 90mm)	—			
Light source	Red LED							
Sensitivity adjustment	—	1 rotation volume	—	1 rotation volume				
Indicator	LIGHT indicator(Red)							
Control output	NPN · PNP Open collector				100mA max./DC 30V			
Test input	Equipped	—						
Ambient temperature humidity	-25~55°C / 35~85%RH There should be no freezing							
Environmental illuminance	Sun light : 20000 lx max. Incandescent light 4000 lx max.							
Protection category material	IP67(IEC 144)/Metal cover : SUS304 Case : ABS Lens : PC							
Weight	Emitter : approx.20g Others : approx.25g(except cord)							

*1 20×20mm White paper *2 10×10mm White paper *3 Adjustable range for reflector

INPUT AND OUTPUT CIRCUIT DIAGRAMS

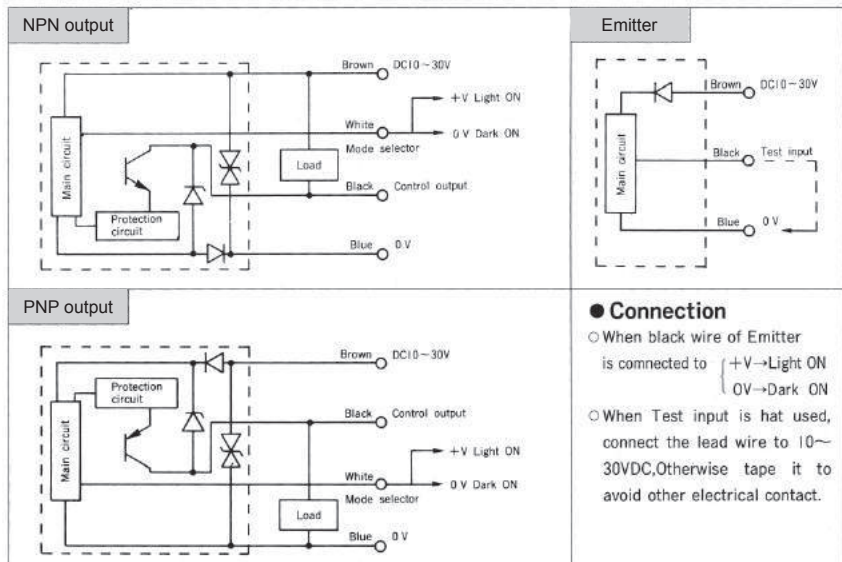

HOW TO USE

● Adjusting the optical axis.

○ Through-beam type

1. Install the emitter and the receiver opposite to each other so that the optical axis lines up.
2. Swing the emitter and the receiver vertically and from side to side, and fix each at the mid-point in the range where the indicating lamp at the receiver lights up.

○ Reflection type

- Swing the sensor vertically and from side to side, and fix it at the mid-point in the range where the indicating lamp lights up.

● Adjusting the sensitivity control

1. Set the detectable object at the detection position and turn the sensitivity control slowly from MIN toward MAX until the indicating lamp lights up. Call it position A.
2. Remove detectable object and turn the sensitivity control from MAX toward MIN position where the indicating lamp is extinguished. Call it position B.

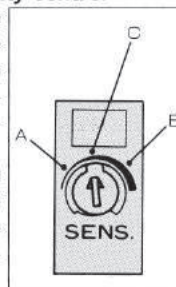

3. Point C midway between A and B is the optimum sensitivity position.

※ Axis checker (Through beam type)

An Axis checker is used to confirm the axis of through beam types. Just place the Axis checker at 1mm distance in front of the receiver, and confirm the receiver works properly repeating ON and OFF.

● TEST INPUT function

(Available only in Emitter)

When the Test input wire is connected to 0V, an interrupted status is electrically invented by stoppage of emission. this function can be used as the operational check of the sensor by electric interrupted state without detectable object.

● Other precautions

- Be careful not to install the sensor at the following locations, for it may otherwise malfunction :
 - Where a lot of dust, vapor, or the like is present
 - Where corrosive gases are produced
 - Where water, oil or the like flies directly onto the sensor.
 - Where strong vibration or shock is causted to the sensor.
- Do not use organic solvent, such as thinner, to remove contaminants from the body case, lid, and lens which are all of plastics. Using a dry rag, just wipe clean.
- When a switching regulator is to be used with a power supply, be sure to ground the frame ground terminal
- Avoid wiring together with high voltage or motor line in order to prevent the sensor from noise.
- Do not use the sensor in a transient state at power on. (about 100 ms)

● Accessories

- Standard reflection mirror Type V-61 (for Retro-reflection, Transparent model)

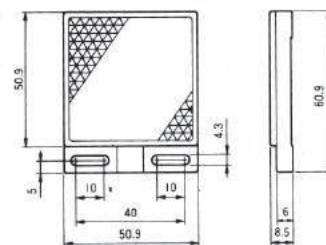

- Optional reflection mirror Type V-42

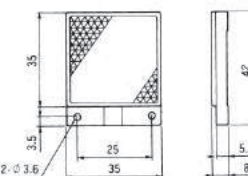

(Unit : mm)

⚠ Must not use this item as safety equipment for the purpose of human body protection.

● Transparent model

(KR-Q50N or P) (KR-Q50CN or CP)

- KR-Q50N(or P), KR-Q50CN(or CP) can take a transparent object. Possible detection is defined by transparency ratio of 85% or less as shown in the list below.

Dumping of transparency(Example)

Material		Dumping (%)
Polyester film	t = 25μm	40
	t = 15μm	24
Glass bottle	φ36mm, t = 0.8mm	48
	φ18mm, t = 1mm	60
Acryle plate	t = 1mm	16
Glass plate	t = 2.6mm	26

- Reflector is V-61.
- Detecting distance is 30cm, object position is midway between reflector and sensor.

● Installation

- Use the attached metals for either vertical or horizontal installation.
- A nut is equipped inside the fixing hole. The nuts are equipped at the position A and B as shown below, so you can install from either way.

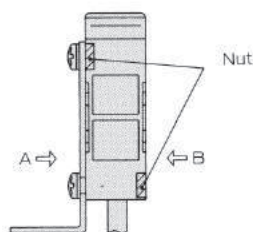

- Screw tightening torque should be 8kgf·cm(0.8 Nm)max.

DIMENSIONS

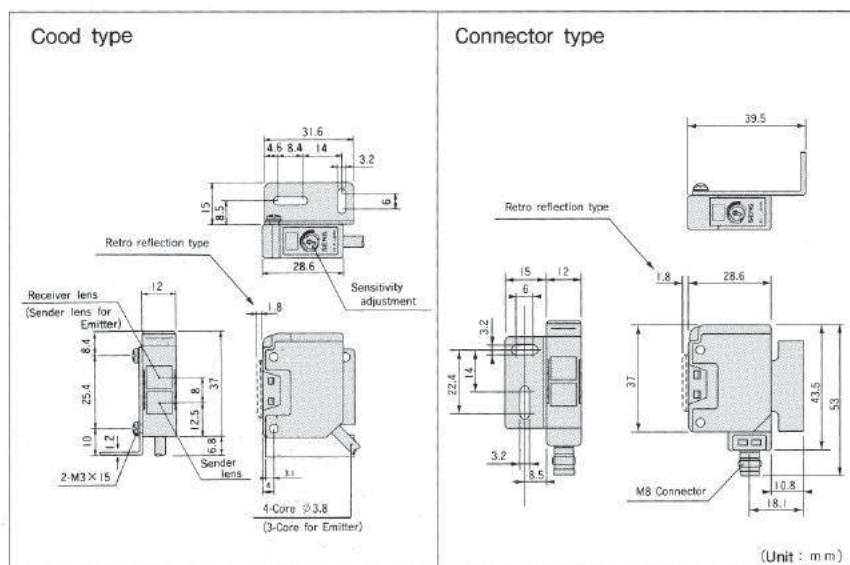

○ Slit(SK-01)

A Slit is an optional accessory for Through-beam type. Just stick it on the 'Upper lens'.

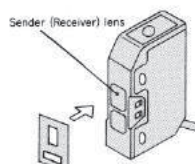

○ Polarizing filter(PFK-01)

A polarizing filter is an optional accessory for Through beam type to avoid mutual interference.

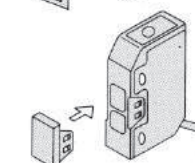

Place a pair of the filter at both emitter and receiver.

Up to two sets of sensors can be tightly installed.

※ Both a slit and a filter can be used simultaneously.

Detecting distance

Slit(both side)	Polarizing filter	Slit (both side)+filter
1m	3m	50cm

- Specifications and equipment are subject to change without any obligations on the part of manufacture.

- For more information, questions and comments regarding products, please contact us below.

Manufactured and sold by

OPTEX FA CO., LTD.

607-8085 Kyoto, Yamashina, Takehanadonomaecho 46-1, JAPAN
Tel: +81-(0)75-594-8123
Fax: +81-(0)75-594-8124

Website : <http://www.optex-fa.com>

0530934