

Color Area Vision Sensor



CVS1-RA Series

CVS1-□10-RA CVS1-□20-RA CVS1-□21-RA CVS1-□40-RA

Instruction Manual

0633133

- Thank you for purchasing this product. Before using this product, confirm that the product you have received is the product that you requested.
- Read this instruction manual thoroughly before use, and keep it in a safe location.



Warning

Indicates that incorrect use may lead to a hazardous situation resulting in injury or death. Also indicates a risk of significant property damage.



Warning

- This product is not explosion-proof and should not be used around flammable or explosive gases or liquids.
- Doing so may cause injury, fire, or electric shock. This product cannot be used as protective equipment for the purpose of protecting the human body.



Caution

- It is dangerous to wire or attach/remove the connector while the power is on. Make sure to turn off the power before operation.
- Installing in the following locations may result in malfunction:
 1. Dusty or steamy locations.
 2. Locations where corrosive gas is generated.
 3. Locations with direct exposure to water or oil splashes.
 4. Locations where heavy vibrations or impacts may occur.
- The product is not designed for outdoor use.
- Do not wire with high voltage cables or power lines. Doing so may cause malfunction or damage by induction.
- Detection characteristics may vary depending on the state of the target object and variations among individual products.
- Do not use the product in water.
- Do not disassemble, repair, or modify this product. Doing so may cause injury, fire, or electric shock.
- Operate within the rated ranges.

INCLUDED ACCESSORIES

Please confirm that the following accessories are included in the box.

- CVS1-□□□-RA
- This instruction manual
- Mounting screws (M4 x 50), 2 pcs. (including washers and nuts)



I/O circuit diagram

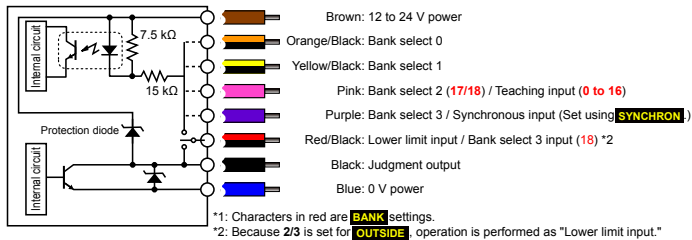

Teach input (pink wire) timing chart (when the specified bank is 0 to 16)

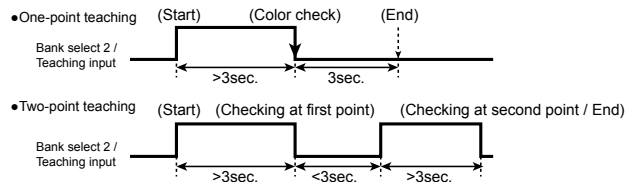

Names of parts

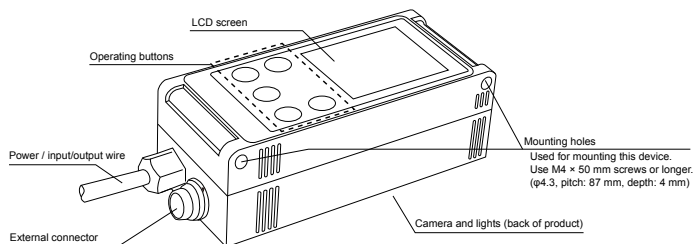

Specifications

Model	CVS1-N10-RA CVS1-P10-RA	CVS1-N20-RA CVS1-P20-RA	CVS1-N21-RA CVS1-P21-RA	CVS1-N40-RA CVS1-P40-RA
Detection angle	10°	20°	31°	40°
Working distance	210 to 270 mm	90 to 150 mm	31 to 39 mm	50 to 100 mm
Field of view (±10%)	40 × 50 mm to 55 × 65 mm	40 × 50 mm to 65 × 75 mm	17 × 20 mm	46 × 55 mm to 82 × 98 mm
Light source	White LED, 12 pcs. built in			
Power supply voltage	12 to 24 VDC			
Current consumption	Max. 140 mA / 24 VDC			
Inspection window size	8×16 to 208×236			
Illumination life	Approx. 50,000 hours (normal temperature and humidity, brightness decreased from initial level by 1/2)			
Response time	18.8 ms (initial setting), 15 ms (min.), 36.4 ms (max.)			
Output signal	NPN/PNP open collector output × 2 Max. 100 mA, 1.0 V residual voltage or less			
Input	Bank selection / Synchronized / External teaching input × 4			
Environmental resistance	Protection category	IP67		
	Operating temperature/humidity	0 to +40°C/35 to 85%RH (no condensation or freezing)		
	Storage temperature/humidity	-20 to +70°C/35 to 95%RH (no condensation or freezing)		
	Vibration resistance	10 to 55 Hz; double amplitude 1.5 mm; 2 hours in each of the X, Y, and Z directions		
	Shock resistance	Approx. 50 G (500 m/s ²), 3 times in each X, Y, and Z direction		
Applicable regulations	EMC compliant (2014/30/EU); RoHS compliant (2011/65/EU)			
Applicable standards	EN 61000-6-2, EN 61000-6-4			
Material	Housing: ABS;		Emitter and receiver: PC	
	Emitter and receiver: Acryl			
Weight	Approximately 200 g			

Dimensions

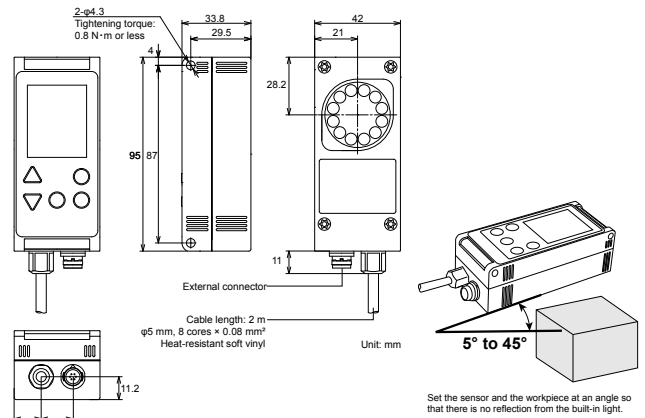

Options

Category	Model	Description
Remote monitor	CVS-M1-R	This is the monitor unit for use with the CVS series. This allows results to be checked away from the workpiece and can be set up similar to the main unit.
Extension cable (3 m)	CVS-C3S	This cable extends the dedicated cable or the remote monitor cable. Up to 4 extension cables can be used (up to 15 m).
External bar light *Requires power supply for light.	OPB-5015W-B OPB-10015W-B	50 mm white light. Use if reflection from internal light is obtrusive. 100 mm white light. Use if reflection from internal light is obtrusive.
Power supply for light	OPPD-15	Required when using an external light.
Mounting bracket for bar light	CVS-OPDB-2000	This bracket is for vertically mounting the OPB-5015W-B (up to 2 can be used).
	CVS-OPDB-3040	This bracket is for horizontally mounting the bar light (up to 2 can be used). Horizontal adjustment up to 30 mm and vertical adjustment up to 40 mm is possible.
	CVS-OPDB-6080	This bracket is for horizontally mounting the bar light (up to 2 can be used). Horizontal adjustment up to 60 mm and vertical adjustment up to 80 mm is possible.

Display description

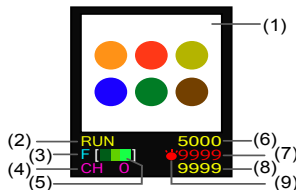

Number	Name	Explanation
(1)	Imaging screen	The image taken by the camera is displayed according to "Screen display mode."
(2)	Mode display	• Operation screen: "RUN" is displayed. • Settings screen: The settings are displayed.
(3)	Screen display mode	Screen display mode for the imaging screen (F: Processing screen / 2: Binarization screen / D: Screen before processing)
(4)	Bank number	Displays the current bank number. (0 to 15)
(5)	Detection color	Shows the color to be detected ("darkest color," "middle color," and "brightest color" from the left).
(6)	Area lower limit	• Operation screen: Shows the lower limit of the detection color area. • Settings screen: Shows the set value for the current item.
(7)	Detection color area	Shows the current area of the detection color (measured value) Red: Within the upper and lower limits, Green: Outside range
(8)	Area upper limit	• Operation screen: Shows the upper limit of the detection color area. • Settings screen: Shows the response time (unit: 0.1 ms)
(9)	Output status	• Output ON; ×: Output OFF

Operation with the operating screen

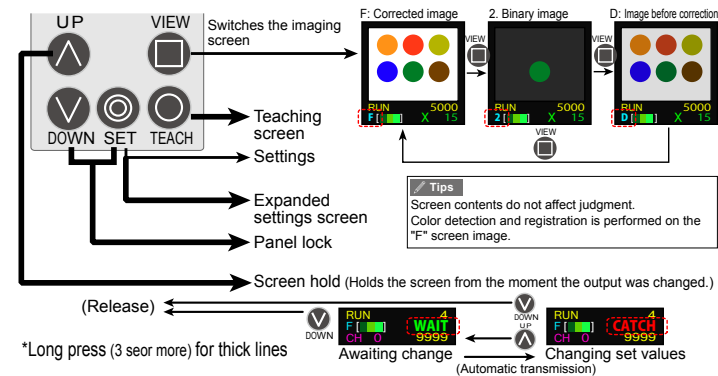

Setup procedure

Settings screen and initialization for the application

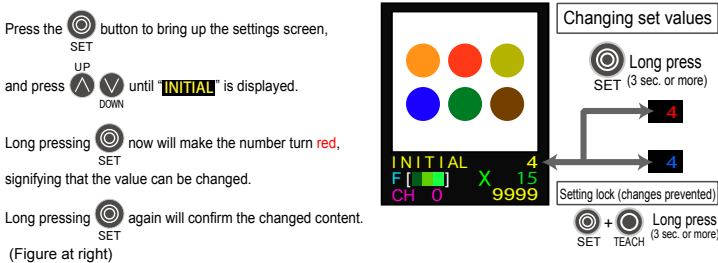

Application	Printing presence	Glossy, transparent printing	Subtle color differences	Gloss presence	Black-and-white detection (white background)	Black-and-white detection (black background)	Differences between dark colors	Printing presence (unbalanced background)
	Expiry date 2004.8.25							Expiry date 2004.8.25
INITIAL setting	1	2	3	4	5	6	7	8
COLORFIL	1	1	0	0	1	0	0	0
KIL BLK	27	27	27	20	27	15	30	15
LIGHT	3	2 ³	3	3	3	3	3	3
RESOLUT	0	0	0	1	1	1	0	0
TEACHMD	1	1	0	2	0	0	0	1
Shooting area ⁴	200×120	200×120	200×240	200×240	200×120	200×120	200×240	200×120
Teaching area	Normal	Normal	Small	Small	Normal	Normal	Small	Normal

- *1: Executing "INITIAL" will initialize all set values.
- *2: Selecting "15" as the set value will initialize to the standard initial value.
- *3: Use diffuse illumination or backlighting to reliably detect printing without photographing gloss.
- *4: With "200 × 120", the center of the entire screen is zoomed in twice as the shooting area range.

Teaching

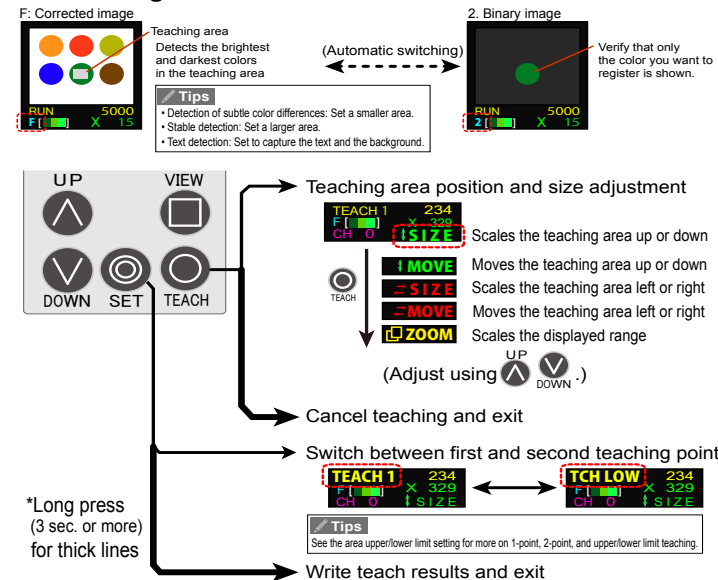

Setting items

- Set items list (Set values for purple set items are maintained for each bank)

Function name	Screen display	Setting range (Initial value)	Function
Darkness correction value	KIL BLK	0 to 31 (27)	This value changes the strength of the brightness variation correction. (0 (weak) to 31 (strong)) [Usage example] 0 to 10: Illumination check, 10 to 20: Achromatic color, 24 to 28: Standard, 29 to 31: Identification of dark color
Initialization	INITIAL	0 to 15 (0)	1 to 8: Initialization of initial values for the application 15: Initialization to the standard initial values.
Input time constant	IN FILT	0 to 4 (4)	This is the input time constant (noise removal time) for bank switching and external teaching. 0: 160 us / 1: 2.5 ms / 2: 5 ms / 3: 7.5 ms / 4: 10 ms (±20%)

Area hysteresis	HYSTERSY	0 to 200 (10)	Sets the area upper and lower limit hysteresis. Setting a value of 1 is equivalent to 0.1% of the entire screen (area value: 9999).
Color filter	COLORFIL	0 to 3 (0)	0, 2: Calculates the RGB ratio per pixel. Resistant to shadows and uneven illumination, but not suitable for achromatic (black and white) use. (2: 2x brightness) 1, 3: Brightness is corrected based on the right edge of the screen. Suitable for detection of black and gray. (3: 2x brightness)
Color margin	COLOR%	0 to 127 (20)	The following values will be automatically registered when teaching. Color range within the teaching area × TEACH% = 10 • Set a smaller value to detect subtle color differences (5 to 20). • Set a larger value to increase stability. (20 or higher)
Shutter time	BRIGHT	0 to 255 (100)	This is the shutter time. Adjustment is automatic when teaching. Set value × 54.5 μs
Bank selection	BANK	0 to 18 (17)	0 to 15: Switches to the specified bank. 16 to 18: Bank switches via external input (see I/O circuit diagram). Banks can be specified with a binary number (Example: Bank 10 → Bank selection 1/3 turns ON)
Area upper limit	AREA HI	0 to 9999 (0)	0: The upper limit is fixed at 9999, and only the lower limit is registered during teaching. 1 and above: The upper/lower limit teaching mode is entered, and the first color area is registered as the upper limit.
Area lower limit	AREA LO	0 to 9999 (5000)	This is the lower limit for the detection area.
Temperature compensation level	TEMPCMP	0 to 255 (0)	Used when temperature changes may have an effect on color detection. Adjust this value so that teaching at low temperatures and measured values at high temperatures are the same. *Adjust only when COLORFIL = 0, 2 and RESOLUT = 1.
Teaching color margin	TEACH%	0 to 30 (15)	Sets the color margin when teaching. (See COLOR%)
Teaching mode	TEACHMD	0 to 3 (0)	0, 2: Normal teaching Sets the brightest and darkest colors in the teaching area as the detection color. 1, 3: Dirt, text detection teaching Sets the darkest color in the teaching area as the detection color. 2, 3: Teaching is done without changing the shutter time (BRIGHT).
Teaching function enabled	TEACHEN	0 to 3 (0)	0: Changing, moving, and zooming of the teaching area is permitted. 1: Zooming in/out is prohibited. 2: Changing and moving of the teaching area is prohibited. 3: Switching to teaching mode is prohibited.
Synchronous input	SYNCHRO	0 to 4 (0)	0: While OFF / 1: When going from ON to OFF / 2: While ON / 3: When going from OFF to ON / 4: Always *When set between 0 and 3, bank selection 3 becomes the synchronous input. *When set to 1 or 3, the screen will not be updated directly after button operation, but the judgment will be successful. Display shifts also have no effect on the judgment.
Synchronous input delay time	SYNCDLY	0 to 255 (0)	The synchronous input (bank selection 3) signal will be delayed the set value × 64 μs. Used for fine-tuning of the imaging timing.
Resolution	RESOLUT	0, 1 (1)	0: High resolution (240×200), used for detection of subtle color differences and fine print 1: High speed (120×200), used to increase the response speed
Outside area range specification	OUTSIDE	0 to 3 (0)	0, 2: Output is ON within the area upper/lower limit range. 1, 3: Output is ON outside the area upper/lower limit range. 2, 3: Lower limit output / extended output (red/black wire) becomes output equal to or greater than the area lower limit.
One-shot output	ONESHOT	0, 1 (1)	1: Turns the output ON when the judgment output is ON for the period of "OFF delay time" set time.
ON delay time	ONDELAY	0 to 5000 (0)	Turns the output ON when the judgment result is ON for a period longer than the set time (ms).
OFF delay time	OFFDELAY	0 to 5000 (0)	Turns the output OFF when the judgment result is OFF for a period longer than the set time (ms).
Area display max. value	MAXAREA MAX	0 to 3 (0)	Sets the maximum value for the area. The color area display value is converted (scaled) to the actual area for use with direct reading.
Light ON/OFF	LIGHT	0 to 3 (3)	0, 2: Internal light = OFF, external light = ON 1, 3: Internal light = ON, external light = OFF 2, 3: Illuminate only when imaging with synchronous input (1,3) configured (excludes time immediately following button operation)
LCD vertical flip	LCD VIEW	0 to 3 (0)	0, 2: Normal orientation / 1, 3: Upside-down display 2, 3: If no button is pressed for 1 minute, the LCD will turn off and the NTSC composite video signal will be output.

Expanded setting items

Function name	Screen display	Setting range (Initial value)	Function
Language selection	LANG	0, 1 (0)	Selects the language of the menus. 0: English / 1: Japanese (kana)
Image selection	IMG SEL IMG SEL	0 to 8 (0)	Selects the input image. 0: Original / 1: Index gradation / 2: Red only / 3: Green only / 4: Blue only 5: Low brightness only / 6: Middle brightness only / 7: Special
Bank copy	BANKCOPY	0 to 15 (0)	Click this button to copy the current bank settings to the specified bank.
Extended display	EXV EXV	0 to 3 (0)	Displays the internal status of the unit on an LCD only. 0: In case of emergency / 1: Display (blue) / 2: Display (green) / 3: Display (red)
Communication speed	BAUD	0 to 3 (3)	Sets the communication speed. 0: 9.6 kbps / 1: 14.4 kbps / 2: 57.6 kbps / 3: 115.2 kbps
Illumination luminance difference	LED PAN LED	0 to 100 (50)	Adjusts the percentage of brightness of the top and bottom built-in lights. 0: Illuminate with only the top light, 50: Illuminate with both top and bottom light, 100: Illuminate with only the bottom light
Illumination brightness	LED BRI LED	0 to 255 (170)	Adjusts the brightness of the built-in light. 0: Off, 255: Max. brightness

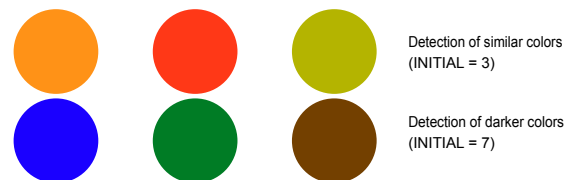

- Product specifications are subject to change without prior notice.
- For more information, questions, or comments regarding this product, please contact us by any of the following means.

Manufactured and sold by :

OPTEX FA CO., LTD.

Headquarters: 4F, Kyoto Research Park Building No. 9,
91, Chudoji-Awata-cho, Shimogyo-ku, Kyoto 600-8815, JAPAN
TEL: +81-(0)75-325-1314 FAX: +81-(0)75-325-2921

OPTEX FA Homepage

<http://www.optex-ramco.com>

Need Tech Support? Contact Ramco 515-225-6933