

X97-Z304

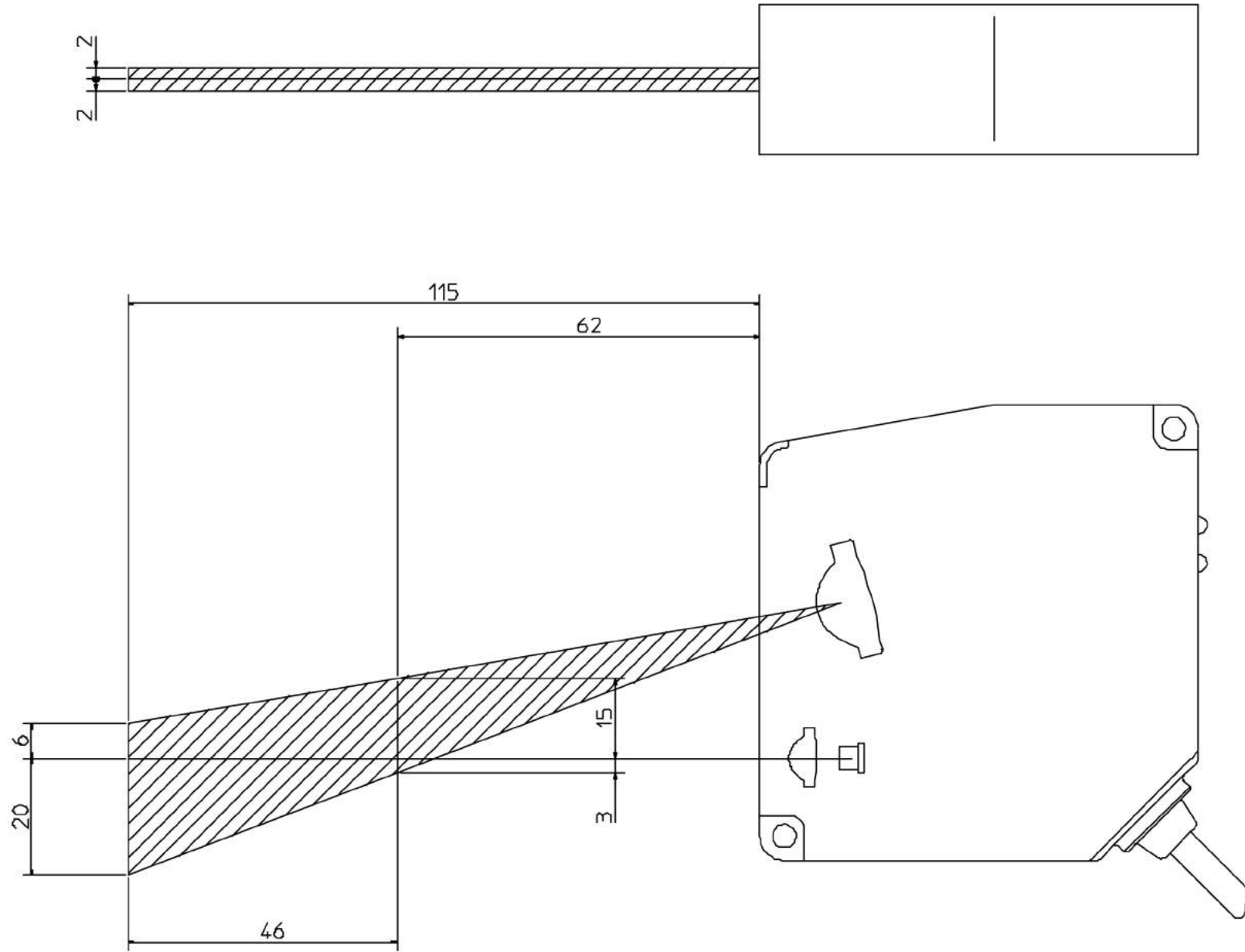

CON.NO	QUAN	NAME	MATERIAL	STANDARD	DISPOSAL	REMARK
A3	SCALE x	UNIT mm	DATE 2008.3.10	DESCRIPTION CD5-85 Interference area		
APPROVED BY K.Matsumoto	CHECKED BY K.Matsumoto	DRAWN BY S.Nishimura	DESIGNED BY S.Nishimura	ITEM		
3RD ANGLE PROJECTION	OPTEX FA CO.,LTD.			DRAWING NO	X97-Z304	