

X103-Q013

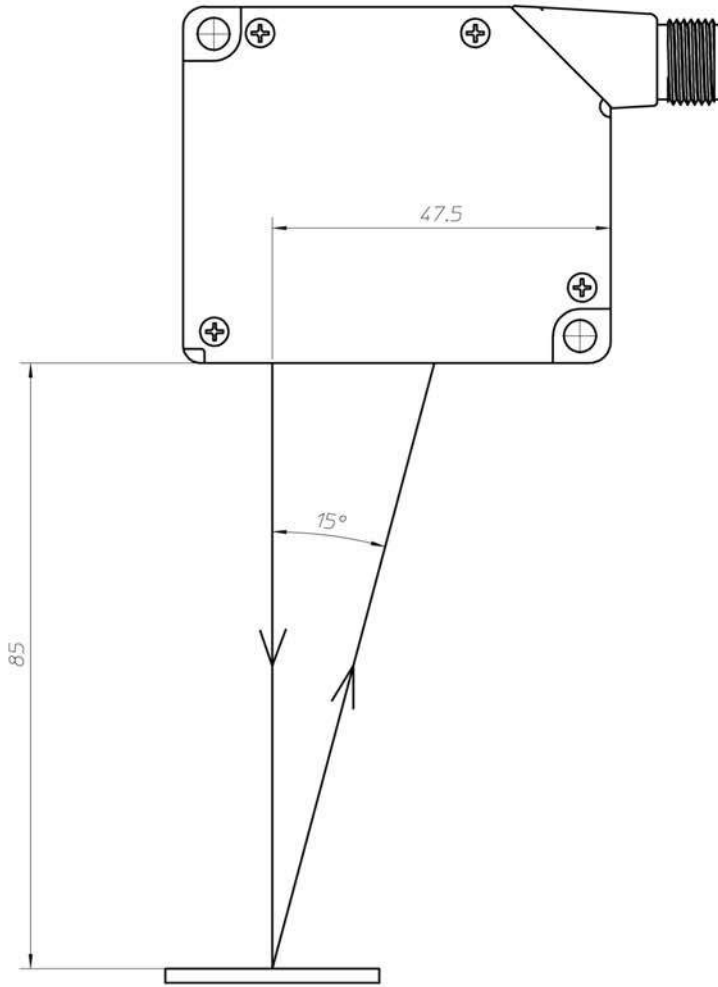

CON.NO	QUAN	NAME	MATERIAL	STANDARD	DISPOSAL	REMARKS
A4	SCALE 1/1	UNIT m.m.	DATE 2008.7.31	DESCRIPTION CD33 85mm type		
APPROVED BY K.Matsumoto	CHECKED BY K.Matsumoto	DRAWN BY Shirakawa	DESIGNED BY Shirakawa	ITEM Optical Axis		
3RD ANGLE PROJECTION	OPTEX FA CO.,LTD.		DRAWING NO	X103-Q013		